

MDS-10

Dual Sensor Detector

Operations Manual

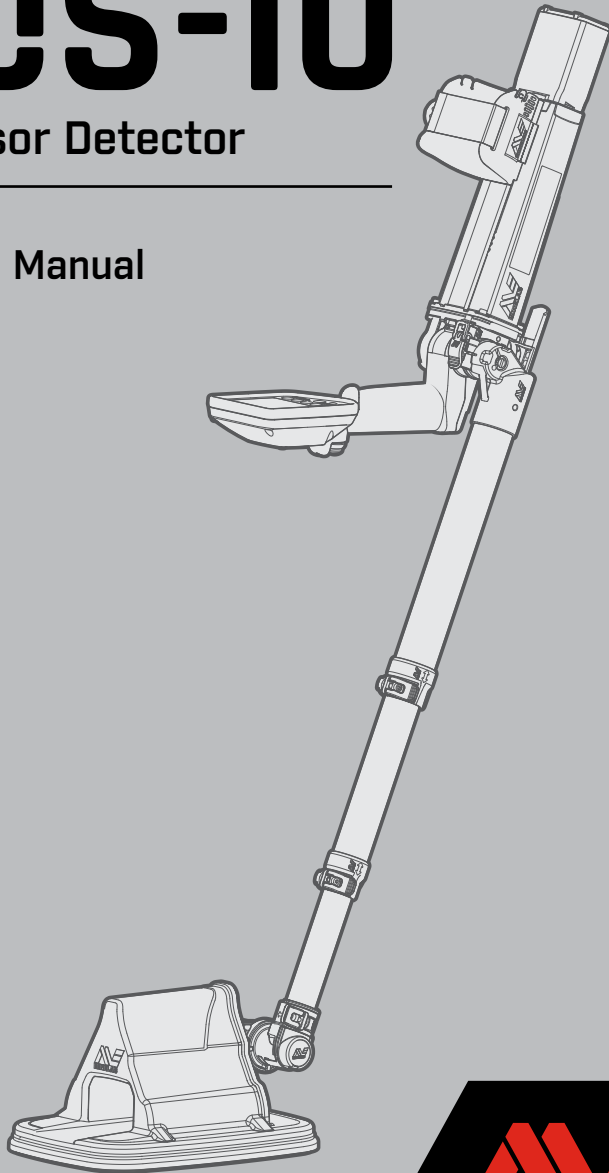

DISCLAIMER

THIS DOCUMENT CONTAINS INTELLECTUAL PROPERTY, TECHNICAL AND PROPRIETARY DATA AND INFORMATION AND OTHER MATERIAL OWNED SOLELY BY MINELAB ELECTRONICS PTY LIMITED. THIS MATERIAL MUST NOT BE USED WITHOUT THE PRIOR WRITTEN PERMISSION OF MINELAB ELECTRONICS PTY LTD.

© Minelab Electronics Pty Ltd. All Rights Reserved.

This document is protected by copyright. Apart from any use permitted under the Australian Copyright Act 1968 (Cth) or other applicable laws, any unauthorised use, appropriation or reproduction of this document or any part of it is strictly prohibited. No part of this document may be used or reproduced by any means or by any process, in any form, without the prior written permission of the copyright owner Minelab Electronics Pty Ltd of 2 Second Avenue, Mawson Lakes SA 5095, Australia.

Patents and Trademarks

Patents may apply to this product: www.minelab.com/patents

Minelab® and MDS-10® are trademarks of Minelab Electronics Pty. Ltd.

MDS-10

Dual Sensor Detector

Operations Manual

Contents

System Overview

MDS-10 Overview.....	6
----------------------	---

MDS-10 Kit Contents.....	7
--------------------------	---

Standard Items	7
----------------	---

Optional Items	7
----------------	---

MDS-10 Main Detector Parts.....	8
---------------------------------	---

MDS-10 Detector	9
-----------------	---

Operating Modes Overview	10
--------------------------------	----

Dual Sensor Mode (Default)	10
----------------------------	----

MD Mode	10
---------	----

GPR Mode	10
----------	----

Additional Settings Overview	11
------------------------------------	----

Setup Screen	11
--------------	----

Additional Functions and Settings	11
-----------------------------------	----

Getting Started

MDS-10 Unfolding Procedure	12
----------------------------------	----

User Interface	14
----------------------	----

LCD Screen.....	16
-----------------	----

Detect Screen	16
---------------	----

Setup Screen	18
--------------	----

Setup Pages	19
-------------	----

Pause Screen	19
--------------	----

Quick Start	20
-------------------	----

MD Test Piece.....	22
--------------------	----

MD Test Piece Procedure	22
-------------------------	----

GPR Test Target	23
-----------------------	----

GPR Test Target Procedure	23
---------------------------	----

Settings Adjustment

LCD and LED Indicator Settings	24
--------------------------------------	----

LCD and LED Brightness	24
------------------------	----

Turn the LCD On or Off	24
------------------------	----

Night Vision Mode	24
-------------------	----

Sensor Feedback Settings	25
--------------------------------	----

Selecting Sensor Feedback Settings	25
------------------------------------	----

Visual Feedback	26
-----------------	----

Audio Feedback	26
----------------	----

Vibration Feedback	26
--------------------	----

Tactical Mode	26
---------------	----

User Interface Feedback	26
-------------------------	----

Detector Audio	27
----------------------	----

Volume	27
--------	----

Audio Output Modes	27
--------------------	----

MDS-10 Earset Audio	28
---------------------	----

Personal Role Radio Adapter Cable	28
-----------------------------------	----

3.5 mm (1/8") Audio Adapter Cable	28
-----------------------------------	----

MD Overview

MD Sensor Overview	29
--------------------------	----

Enabling the MD Sensor	29
------------------------	----

MD Trace	29
----------------	----

MD Sensor Modes	30
-----------------------	----

Detection Mode (Default)	30
--------------------------	----

Pinpoint Mode	30
---------------	----

Interrogation Mode	30
--------------------	----

MD Sensor Overload	30
--------------------	----

MD Ground Balance	31
-------------------------	----

MD Sensor Calibration	31
-----------------------	----

MD Ground Balance Procedure	32
-----------------------------	----

Ground Balance Mode	33
---------------------	----

Selecting the Ground	
----------------------	--

Balance Mode	33
--------------	----

MD Noise Cancel.....	34
----------------------	----

MD Noise Cancel Procedure	34
---------------------------	----

Nearby Detectors Procedure	34
----------------------------	----

MD Sensitivity	35
----------------------	----

Setting the MD Sensitivity	35
----------------------------	----

GPR Overview

GPR Sensor Overview.....36

Enabling the GPR Sensor	36
GPR Standby Mode	36

GPR Skyshot37

GPR Sensor Calibration	37
GPR Skyshot Procedure	38

GPR Sensitivity.....39

Setting the GPR Sensitivity	39
-----------------------------	----

Advanced GPR Settings40

GPR Start/Stop Gates	40
Setting the Start/Stop Gates	40
GPR Detection Threshold	41
Adjusting GPR Detection Threshold	41
Play/Pause	42
Pause the GPR Imagery/ MD Trace	42

GPR Imagery Overview43

Basics of GPR Imagery	43
Parts of the GPR Imagery	43
Detection GPR Imagery	44
Deep and Shallow Anomaly Imagery	44
Detection Sweep-Speed Effect	44
Noisy GPR Imagery	44
Common Ground Type Imagery	45

Operating Procedures

Search Technique46

Search Speed	46
Search Overlap	46
Search Height	46

Locating the Target47

Mapping the Target	47
Target Mapping Procedure	47
MD Search Tips	48
MD Edge Mapping Procedure	49
Mapping Multiple Targets	49
MD Pinpointing Procedure	50

MD Interrogation Mode51

Interrogation Mode Audio	51
Interrogation Mode Procedure	51
Parts of the Target ID Field	52
MD Target ID	52
Target ID Examples	52

Accessories

Detector Battery53

Battery Status Indicator	53
Low Battery Alert	53
Lithium-ion Battery Charger	53
Charging the Lithium-ion Battery	54
Charge Status LED	54
Conditioning the Lithium-ion Battery	54
Optional AA Battery Carrier	55

Troubleshooting, Safety, and Maintenance

Troubleshooting56

Error Codes58

Critical Errors	58
Advisory Errors	59
Fatal Errors	59
System Error Codes	59
MD Error Codes	60
GPR Error Codes	60

Factory Presets61

Factory Preset Settings	61
Factory Reset	61

Safety Advice and Maintenance62

Specifications

MDS-10 Detector Specifications64

MDS-10 Overview

The MDS-10® combines unique Metal Detection (MD) and Ground Penetrating Radar (GPR) technologies to provide superior results in the detection of buried metal and non-metal explosive device components including:

- Wires
- Cluster munitions
- Improvised explosive devices
- Unexploded ordnance
- Landmines

Dual Sensor Technology

The MDS-10 combines Minelab's patented Simultaneous Multi-Frequency Digital technology and Chemring's proven Ultra Wideband Impulse Radar to detect all conductive and non-conductive targets of interest in varied soil conditions and operating environments.

Metal Detection (MD) and Ground Penetrating Radar (GPR) sensors can operate independently or simultaneously, providing selectable visual, vibration, and audio feedback to the Operator.

The MD Sensor detects metal and some conductive non-metal objects (such as carbon rod IED switch components).

The GPR Sensor is capable of detecting non-metal and metal objects appearing as sub-surface ground anomalies.

Rugged and Compact

Constructed from impact resistant materials, the MDS-10 is designed to survive in many operating environments.

Each detector is supplied in an impact resistant hard transit case that contains the MDS-10, a tough nylon carry bag, and accessories.

MDS-10 is compact and lightweight to reduce fatigue during extended operation.

Ease of Use

The User Interface features a versatile colour LCD screen and is designed for intuitive operation and minimising Operator training requirements.

Safe

It is not possible to accidentally disable both sensors or all detection feedback modes.

It includes a Built-in Test (BIT) capability to monitor and confirm detector functionality.

Additional Features

- Continuous real-time display of MD and GPR detections with the ability to pause graphical imagery for scrutiny of potential targets.
- Adjustable MD and GPR Sensitivity with Volume control.
- Target Classification for MD Sensor targets (Conductivity, Ferrous/Non-ferrous, Carbon Rod indications).
- Fully enclosed and protected cables.
- Screen is viewable in bright sunlight.
- Tactical Mode for night operations.
- Waterproof to 3 m/10'.
- Compatible with Night Vision Imaging Systems (NVIS).

MDS-10 Kit Contents

The MDS-10 is supplied as a complete kit packed in a hard transit case for storage and transportation.

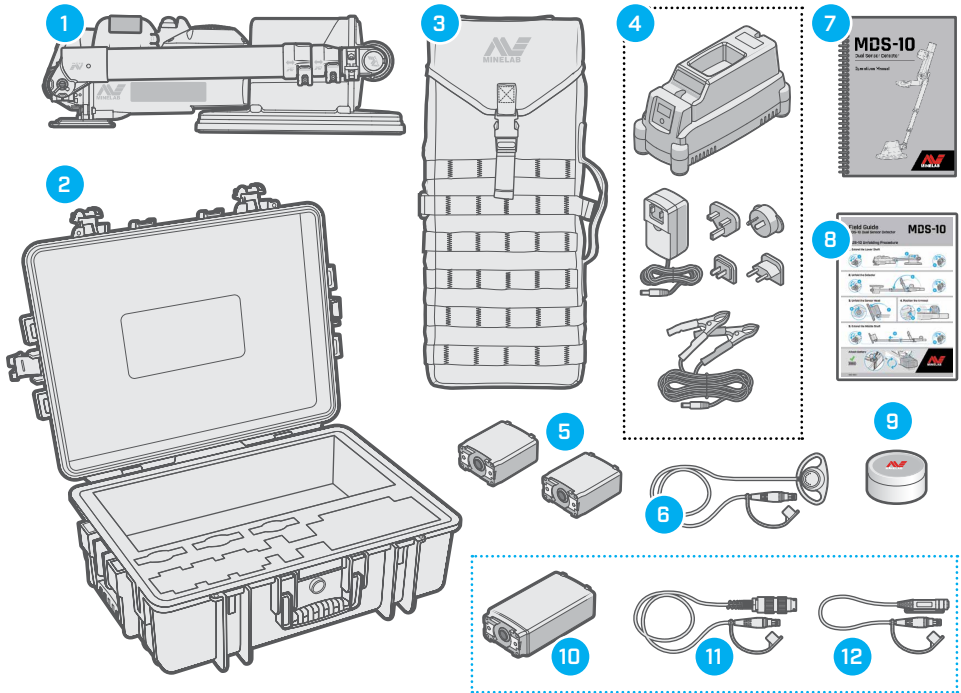

Standard Items

1. MDS-10 Detector
2. Hard Transit Case
3. Carry Bag
4. Battery Charger
5. Lithium-ion Rechargeable Battery (x2)
6. MDS-10 Earset
7. Operations Manual
8. Field Guide
9. GPR Test Target

Optional Items

10. AA Battery Pack
11. Personal Role Radio Adapter Cable
12. 3.5 mm (1/8") Audio Adapter Cable

Items and specifications may vary slightly from those shown and may be subject to change.

! **Important Safety Warnings and Advice:** Before operating the MDS-10, read Safety Advice and Maintenance on page 62.

MDS-10 Main Detector Parts

The major parts listed are referred to throughout this Operations Manual.

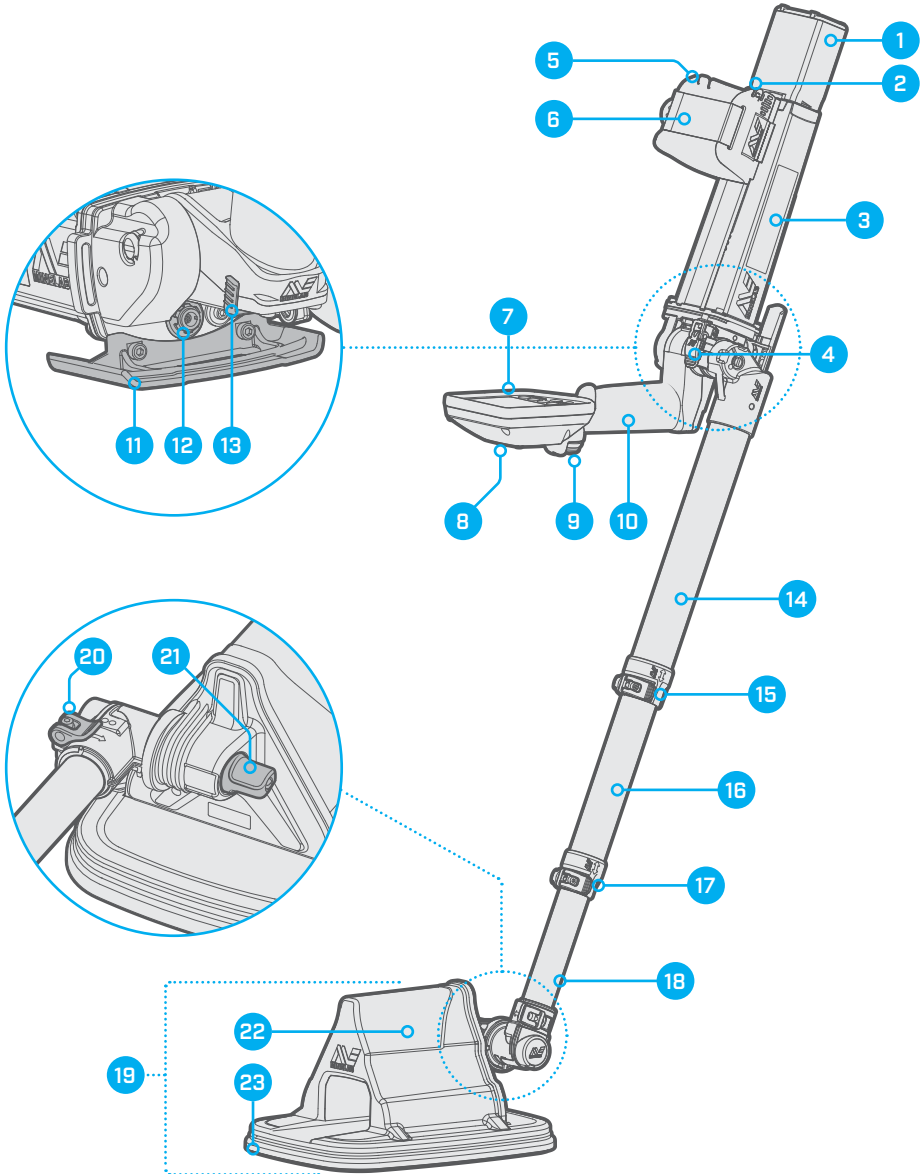

MDS-10 Detector

1. Lithium-ion Rechargeable Battery
2. Battery Release Lever
3. Control Box
4. Lateral Shaft Camlock
5. Adjustable Armrest
6. Armrest Strap
7. User Interface
8. Speaker
9. Trigger Button
10. Folding Handle
11. Stand
12. Earset Connector
13. MD Test Piece
14. Upper Shaft
15. Upper Shaft Camlock
16. Middle Shaft
17. Lower Shaft Camlock
18. Lower Shaft
19. Sensor Head
20. Sensor Head Rotation Camlock
21. Sensor Head Pivot Tension
22. GPR Antennas
23. Metal Detection Coil

Attachment Points

Sturdy attachment points are located near the front of the control box. These are sized to fit standard 25 mm (1") webbing straps for attachment to load carrying equipment.

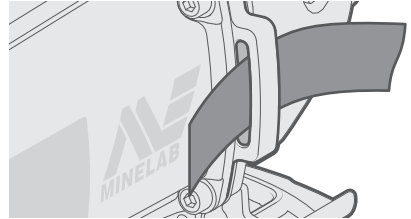

Earset Cable Retention Notches

There are Earset cable retention notches located on each side of the armrest.

Loop excess Earset cable through to manage excess cable length, if required.

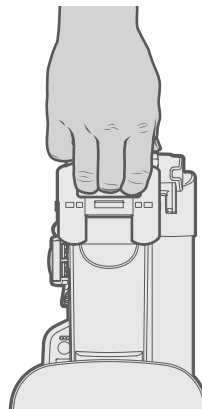

Stand

The stand can also be used as a carry handle.

Operating Modes Overview

The MDS-10 has three main operating modes; Dual Sensor Mode, MD Mode, and GPR Mode.

Dual Sensor Mode (Default)

In Dual Sensor Mode, both MD and GPR Sensors are operational and provide detection feedback to the operator.

Operation in Dual Sensor Mode is achieved by enabling both the MD (page 29) and GPR (page 36) Sensors, and is the default operating mode.

To differentiate between sensors, there are different audio tone responses for each sensor.

Each sensor has separate colour coded Target Indicator LEDs for visual response (MD LEDs are red, GPR LEDs are yellow). However, the vibration response is indistinguishable between sensors.

MD Mode

In MD Mode, the MD Sensor is enabled, and the GPR Sensor is disabled.

The following MD Sensor Modes are available in both MD Mode and Dual Sensor Mode:

- **MD Detection Mode** – this mode is optimised for maximum detection performance and is the primary MD Sensor Mode (page 30)
- **Pinpoint Mode** – this mode provides a static detection response that is useful for localising targets (page 30)
- **Interrogation Mode** – this mode provides additional information regarding probable target characteristics (page 30)

The following additional MD functions are also available in both MD Mode and Dual Sensor Mode:

- **MD Ground Balance** – a calibration function that reduces MD false detection responses caused by ground mineralisation (page 31)
- **MD Noise Cancel** – this function minimises MD interference from nearby electronic sources (page 34)
- **MD Sensitivity** – this function allows the user to set MD Sensitivity (page 35)

GPR Mode

In GPR Mode, the GPR sensor is enabled and the MD Sensor is disabled.

The following GPR Sensor functions are available:

- **GPR Skyshot** – a calibration function that removes the GPR's own 'self signature' from the target response (page 37)
- **GPR Sensitivity** – this function allows the user to set GPR Sensitivity (page 39)
- **GPR Advanced Settings** – these functions allow the user to set GPR Start/Stop Gates, and the GPR Detection Threshold (page 40)

Additional Settings Overview

The MDS-10 has a Setup Screen accessible in all operating modes enabling the user to access more settings.

Setup Screen

The Setup Screen (page 18) is accessible from Dual Sensor Mode, MD Mode and GPR Mode by a short-press of the Setup Button (page 14).

The Setup Screen allows the user to adjust the following settings:

- **MD Ground Balance Mode** (page 33)
- **Audio Output Mode** – for speaker and earset (page 27)
- **MD Sensor Feedback settings** – Visual, Audio and Vibration (page 25)
- **GPR Sensor Feedback settings** – Visual, Audio and Vibration (page 25)

Additional Functions and Settings

The following additional functions and settings can be accessed from Dual Sensor Mode, MD Mode, or GPR Mode:

- **Volume** adjustment (page 27)
- **Play/Pause** – pause the GPR Imagery and MD Trace (page 42)
- **LCD On/Off** (page 24)
- **LCD/LED Brightness** adjustment (page 24)
- **Night Vision Mode** (page 24)
- **Tactical Mode** (page 26)

Refer to the referenced pages for more information.

MDS-10 Unfolding Procedure

Follow these steps to unfold the MDS-10 ready for operation.

Before beginning, remove the detector from the protective hard-case or carry bag.

Extend the Lower Shaft

1. Open the lower shaft camlock.
2. Slide the lower shaft out to full extension.
3. Close the lower shaft camlock.

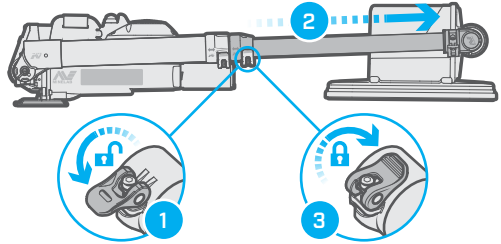

Unfold the Detector

4. Open the lateral shaft camlock.
5. Holding the control box, rotate the Sensor Head and shafts around 180° until the end stop is reached. The handle will follow the shafts.
6. Close the lateral shaft camlock.

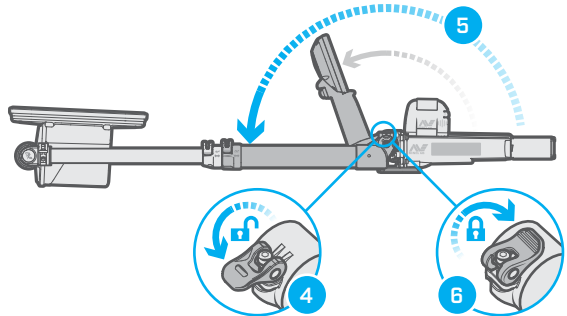

Unfold the Sensor Head

7. Pivot the Sensor Head out. The Sensor Head should be parallel to the ground when held in the detecting position.
8. If required, tighten the tension nut so that the Sensor Head holds its angled position.

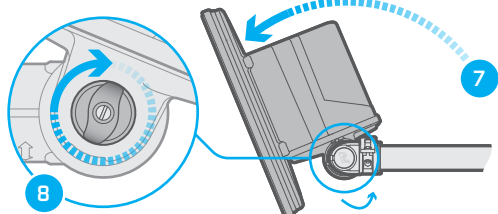

Position the Armrest

9. Squeeze the finger grips on the rear of the armrest to release the locking mechanism.
10. Slide to a comfortable position.

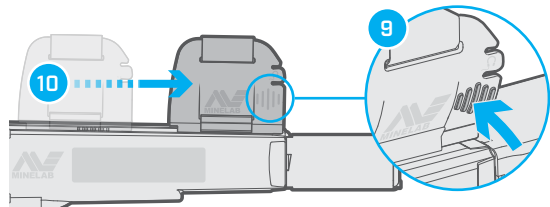

Extend the Middle Shaft

11. Open the upper shaft camlock.
12. Extend the middle shaft.
13. Close the upper shaft camlock.

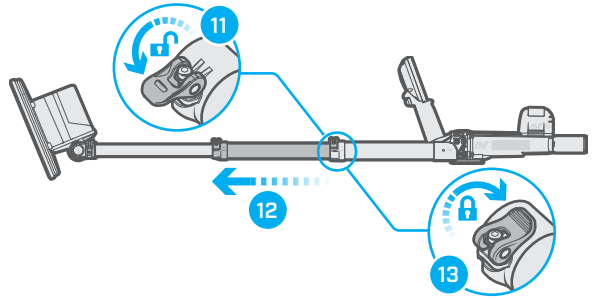

Attach Battery

14. Check that the battery has an O-ring fitted.
15. Align the battery perpendicular to its final position.
16. Depress the Battery Lock Lever.
17. Rotate the battery 90 degrees, then release the lever.

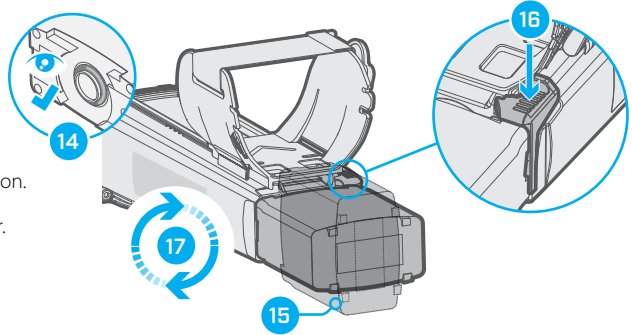

Once the detector is unfolded, proceed to Quick Start on page 20.

MDS-10 Folding Procedure

Repeat the Unfolding procedure steps in reverse.

Note: The MDS-10 can be stowed with the Li-ion battery attached. The battery slides into the cavity inside the Sensor Head when the lower shaft is collapsed.

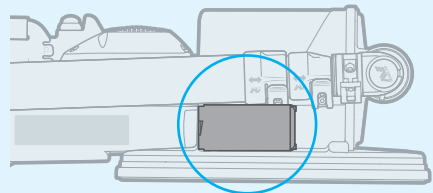

The Lithium-ion battery inside the Sensor Head.

180° Sensor Head Rotation

The MDS-10 Sensor Head can be rotated 90° to both the left and right for detecting on angled surfaces such as the side of a trench.

1. Open the Sensor Head rotation camlock.
2. Rotate to the Sensor Head preferred position.
3. Close the camlock.

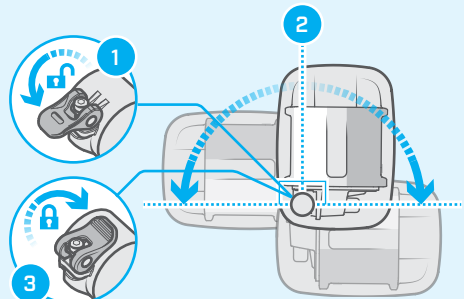

User Interface

The MDS-10 User Interface has a large LCD Screen, a backlight, and a keypad. The User Interface displays and controls all of the detector functions.

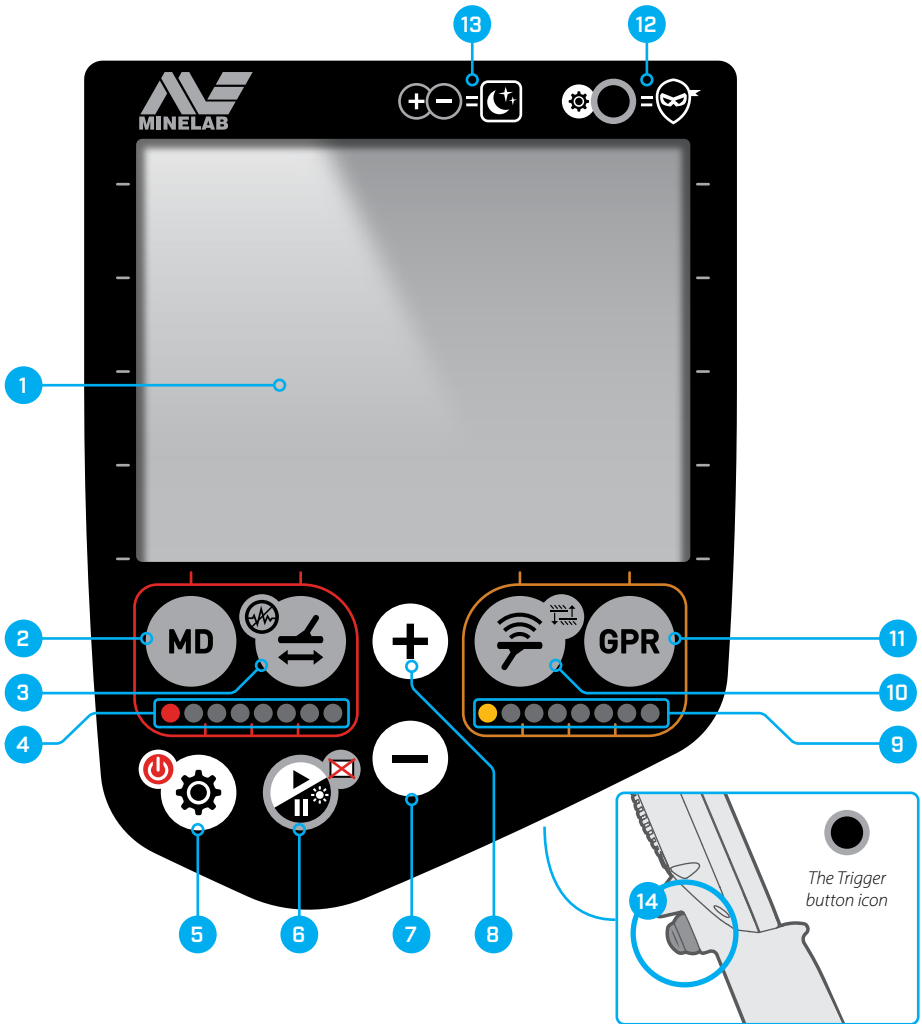

Additional Button Functions

Some buttons are used for more than one function, indicated by a small icon adjoining the button.

Short-press (<0.5s) the button to access its main function.

Long-press (>0.5s) the button to access its additional function.

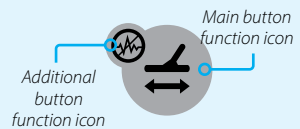

1. LCD

Displays detector settings, options, and detection information (page 16).

2. MD Button

Long-press from the Detect Screen to Enable or Disable the MD Sensor.

Short-press from the Detect Screen to display MD Sensitivity adjustment (page 35).

Short-press from the Setup Screen to display the MD Sensor feedback settings (page 25).

3. Ground Balance Button

Short-press to initiate MD Ground Balance (page 32).

Long-press to initiate MD Noise Cancel (page 34).

4. MD Target Indicator LEDs (Visual and IR)

Red LEDs indicate MD detection signal strength, increasing from left to right.

The LEDs can transmit both visible light, and Infra-red for compatibility with Night Vision Imaging Systems (NVIS).

5. Setup Button

Short-press to display the Setup Screen to adjust the general detector settings and MD and GPR Sensor Feedback settings.

Long-press (1.5s) to turn the detector On and Off.

6. Play/Pause Button

Short-press to Pause/Play the GPR Image and/or MD Trace (disables both MD and GPR Sensor transmitters temporarily when paused.)

Brightness adjustment is only accessible from the Pause Screen, using the Plus and Minus buttons to adjust (page 24).

Long-press to turn the LCD On and Off.

7. Minus Button

Short-press from the Detect Screen to display and decrease the detector Volume level (page 27).

Short-press at the same time as the Plus button to enable Night Vision Mode (page 24).

Short-press from the Pause Screen to display and decrease the LCD brightness level (page 24).

Short-press to decrease the value of a selected detector setting by one level.

8. Plus Button

Short-press from the Detect Screen to display and increase the detector Volume level (page 27).

Short-press at the same time as the Minus button to enable Night Vision Mode (page 24).

Short-press from the Pause Screen to display and increase the LCD brightness level (page 24).

Short-press to increase the value of a selected detector setting by one level.

9. GPR Target Indicator LEDs

Yellow LEDs indicate GPR detection signal strength, increasing from left to right.

The LEDs can transmit both visible light, and Infra-red for compatibility with Night Vision Imaging Systems (NVIS).

10. Skyshot Button

Short-press to initiate a Skyshot calibration process (page 38).

Long-press to display GPR Advanced Settings.

11. GPR Button

Long-press from the Detect Screen to Enable or Disable the GPR Sensor.

Short-press from the Detect Screen to display GPR Sensitivity adjustment (page 39).

Short-press from the Setup Screen to display the GPR Sensor Feedback settings (page 25).

12. Tactical Mode Buttons Reference

Quick-reference showing the button press combination to enable Tactical Mode (page 26).

Press the Plus and Minus buttons at the same time.

13. Night Vision Mode Buttons Reference

Quick-reference showing the button press combination to enable Night Vision Mode (page 24).

Press the Setup button and the Trigger at the same time.

14. Trigger (at rear of user interface)

Press and release to toggle between Interrogation Mode and Detection Mode (page 51).

Press and hold to enable Pinpoint Mode (page 50).

LCD Screen

The MDS-10 LCD displays detector settings, options, and represents target detections visually. Key screens include the Detect Screen, the Setup Screen, and the Pause Screen.

Detect Screen

The Detect Screen displays the real-time detection information for enabled Sensors.



Detect Screen in MD Mode

Most MD information is displayed in the MD display area on the left side of the LCD. Key functions are colour-coded red so they can be easily differentiated from the GPR functions.

When the MD Sensor is disabled, all MD functions are not displayed on the Detect Screen.

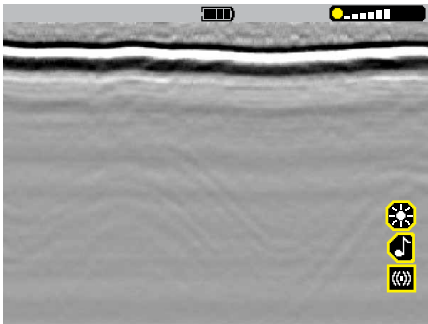

Detect Screen in GPR Mode

Most GPR information is displayed in the GPR display area on the right side of the LCD. Key functions are colour-coded yellow so they can be easily differentiated from the MD functions.

When the GPR Sensor is disabled, all GPR functions are not displayed on the Detect Screen.

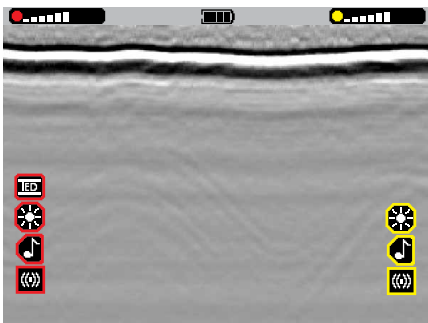

Detect Screen in Dual Sensor Mode

Both MD and GPR information is displayed at the same time. This is the default Mode.

Parts of the Detect Screen

The example below shows the Detect Screen with Factory Preset settings. By default, Dual Sensor Mode is enabled, therefore both MD (red) and GPR (yellow) functions and settings are displayed.

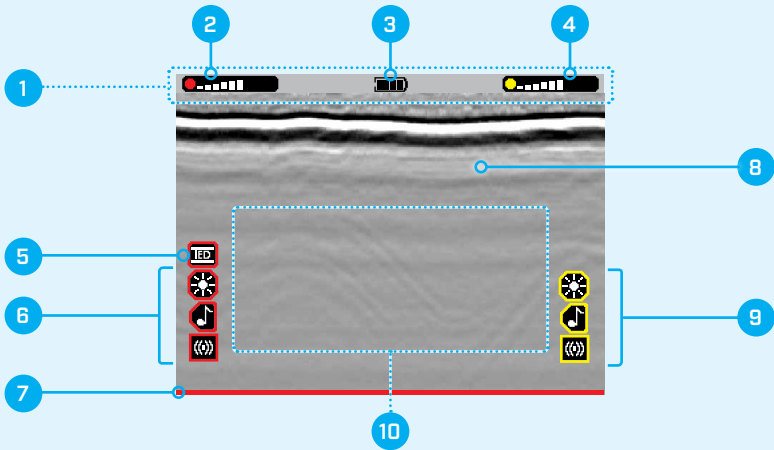

1. Status Bar

Displays quick-reference information for the detector battery level and MD/GPR Sensitivity settings.

! In the event of an Advisory Error, the Advisory Error icon will appear in the status bar (page 59).

2. MD Sensitivity Level Indicator

Displays a visual indication of the MD Sensitivity level (page 35).

3. Battery level Indicator

Displays a visual indication of the battery level (page 53).

4. GPR Sensitivity Level Indicator

Displays a visual indication of the GPR Sensitivity level (page 39).

5. MD Ground Balance Mode

Displays the current Ground Balance Mode (page 33).

6. Enabled MD Feedback Indicators

Indicates enabled MD Feedback settings; Visual, Audio, and Vibration (page 25).

7. MD Trace

Visually represents the responses from metallic targets (page 29).

8. GPR Imagery

Visually represents buried objects and sub surface structures (page 43).

9. Enabled GPR Feedback Indicators

Indicates enabled GPR Feedback settings; Visual, Audio, and Vibration (page 25).

10. Pop-up Indications Area

Displays the status of MD Ground Balance, MD Noise Cancel, and GPR Skyspot processes.

In the event of a Critical System Error, an Error Code and icon will be displayed (page 58).

Indicates when MD Pinpoint and Interrogation Modes are enabled.

Setup Screen

Short-press the Setup button to display the Setup Screen. The example below shows the Setup Screen with Factory Preset settings.

Parts of the Setup Screen

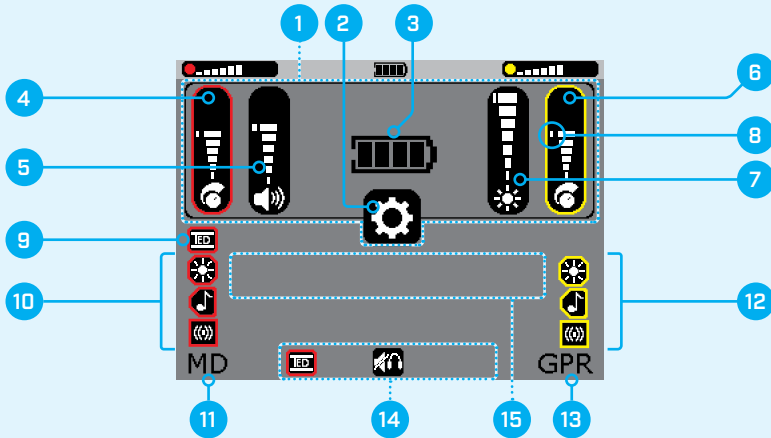

1. Settings Overview Area

Displays the current detector settings. They cannot be adjusted from the Setup Screen.

2. Setup Menu Icon

3. Battery Level Indicator

Displays the battery level (page 53).

4. MD Sensitivity Level

Displays the MD Sensitivity level (page 35).

5. Volume Level

Displays the Volume level (page 27).

6. GPR Sensitivity Level

Displays the GPR Sensitivity level (page 39).

7. LCD/LED Brightness Level

Displays the LCD/LED Brightness level (page 24).

8. Default Setting Markers

The Sensitivity, Volume, and Brightness adjustment bars display a marker to indicate the default setting position.



9. MD Ground Balance Mode

Displays the current Ground Balance Mode (page 33).

10. Enabled MD Feedback Indicators

Indicates enabled MD Feedback settings; Visual, Audio, and Vibration (page 25).

11. MD Setup Page Indicator

12. Enabled GPR Feedback Indicators

Indicates enabled GPR Feedback settings; Visual, Audio, and Vibration (page 25).

13. GPR Setup Page Indicator

14. Soft Key Options

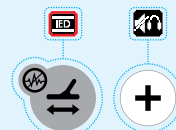

Short-press the button directly below each Soft Key option to select or toggle the available options.

15. Error Code Display Area



In the event of an MD, GPR, or System Error, an Error Code will be displayed (page 58).

Setup Pages

Within the Setup Screen, there are 3 Setup Pages: the General Setup Page, the MD Setup Page, and the GPR Setup Page. Each Page has different Soft Key Options at the bottom of the screen.

The General Setup Page



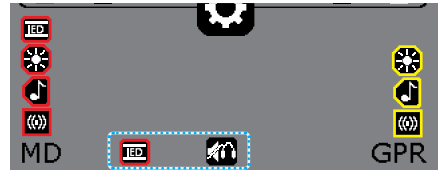

The General Setup Page displays the following Soft-Key Options:

-  Ground Balance Mode
-  Audio Mode







The MD Setup Page

The MD Setup Page displays the following Soft Key Options:

-  MD Visual (LED) Feedback Setting
 -  MD Audio Feedback Setting
 -  MD Vibration Feedback Setting
-  A border appears around the MD Setup Page Indicator when the MD Setup Page is active.

The GPR Setup Page

The GPR Setup Page displays the following Soft-Key Options:

-  GPR Visual (LED) Feedback Setting
 -  GPR Audio Feedback Setting
 -  GPR Vibration Feedback Setting
-  A border appears around the GPR Setup Page Indicator when the GPR Setup Page is active.

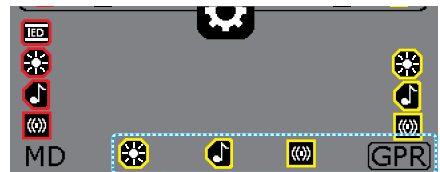
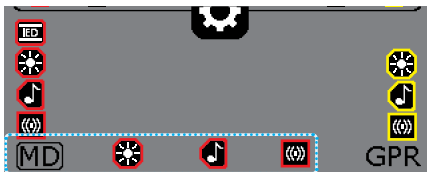

Pause Screen

The GPR Imagery and/or MD Trace can be temporarily paused for scrutiny of detections.

Short-press the Play/Pause button to display the Pause Screen. Note that MD and GPR Sensor transmitters are turned off while Paused.

Read Play/Pause on page 42 for detailed operation instructions.

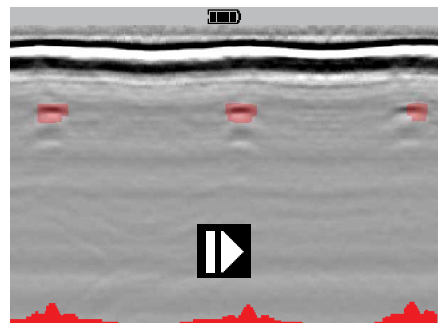

Quick Start

Follow the Quick Start procedure to make the MDS-10 ready for operation.

Begin with an assembled detector
(See MDS-10 Unfolding Procedure on page 12.)

Note: All detector modes and settings are saved after the detector is powered Off, including after removal/replacement of the battery.

When the detector is powered On again, all modes and settings will return to their last-used state.



Tip: Beginning a detecting operation with a fully charged battery is recommended.

See Charging the Lithium-ion Battery on page 54.

Factory Reset

Factory Reset will return all detector settings and modes to factory preset values.

1. Turn the detector Off.
2. Press and hold the Setup (power) button for approximately 5 seconds;
3. After the first start-up tone, there will be a short high-pitched confirmation tone, and all settings and modes will return to factory preset values.
4. Release the Setup (power) button.

1. Turn On

Long-press the Setup button.

Wait for the first MD Target Indicator LED to stop flashing.



2. MD Ground Balance

Carry out the Ground Balance Procedure (page 32).

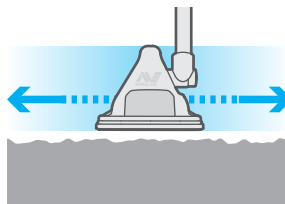
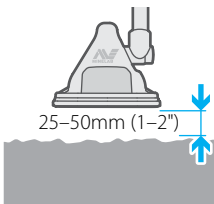

3. MD Test Piece

Carry out the MD Test Piece procedure (page 22) to confirm the MD Sensor is working correctly.

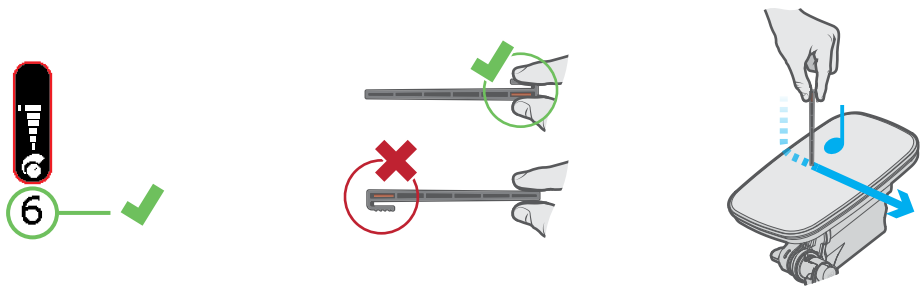

4. GPR Skyspot

Ensure that the first GPR Target Indicator LED has stopped flashing.

Carry out the GPR Skyspot Procedure (page 38).

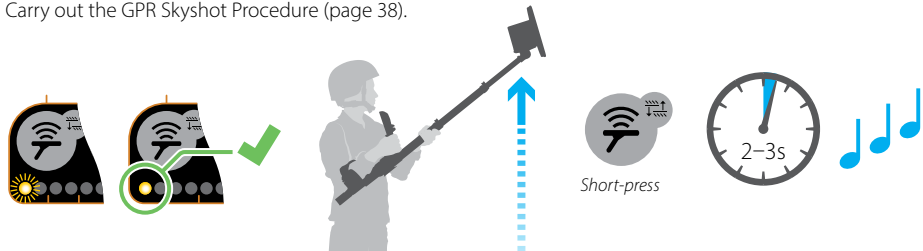

5. GPR Test Target

Carry out the GPR Test Target procedure (page 23) to confirm the GPR Sensor is working correctly.

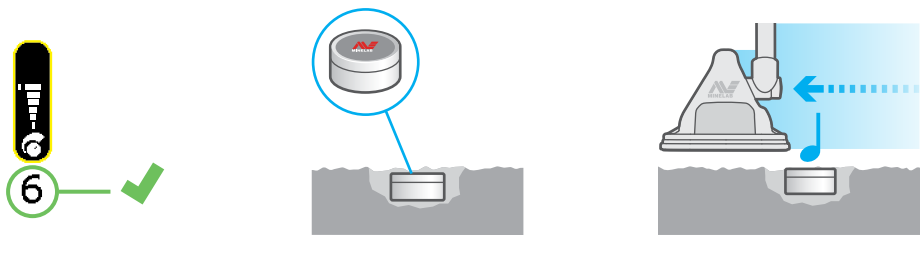

6. Begin Detecting

Begin detecting using the correct search technique (page 46).

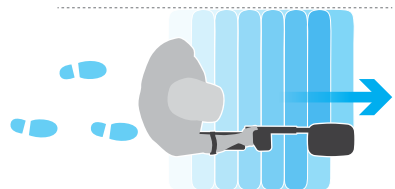

MD Test Piece

The supplied MDS-10 MD Test Piece is used to confirm that the MD Sensor is functioning correctly.

The MD Test Piece procedure should be carried out every time the MDS-10 is powered on.

Always set an MD Sensitivity level of 6 (default) when performing the Test Piece procedure.

In some instances, a user may prefer to use inert mines or targets as test pieces because they represent the local threat. Minelab recommends that the MDS-10 always be first tested with the supplied MD Test Piece before local test pieces are used for testing.



The Minelab MDS-10 MD Test Piece

MD Test Piece Procedure

1. Ensure that hands and arms are free of metallic objects (watches, rings etc.), and that no other metallic objects are near the Sensor Head.

2. Ensure MD Sensitivity is set to 6 (default) (page 35).



3. Remove the Test Piece from its stowed position in the base of the detector's handle.

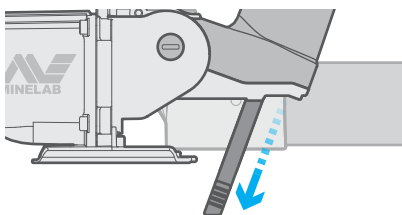

4. Hold the Test Piece by the ridged finger grip.

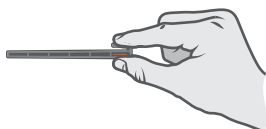

5. Hold the Test Piece perpendicular to the coil. Lightly touching the surface of the coil with the tip of the Test Piece, smoothly and slowly move the test piece across the coil from one side to the other.

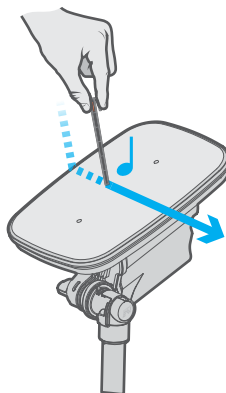

A faint but clear response (a rise in volume) should be heard, indicating the MD Sensitivity level is correct.



With the MD LED display enabled, the Test Piece procedure should result in the illumination of at least one additional LED.

If the Test Piece does not produce a response, Factory Reset the detector (page 61), and then repeat the Test Piece procedure.



If the Test Piece fails to be detected, the detector must be considered faulty and **MD Mode must not be used.**

The MDS-10 may still be used in GPR Sensor Mode.

GPR Test Target

The MDS-10 is supplied with a GPR Test Target to confirm that the GPR Sensor is functioning correctly.

The GPR Test Target procedure should be carried out every time the MDS-10 is powered On.

Always set a GPR Sensitivity level of 6 (default) when performing the Test Target procedure.

In some instances, a user may prefer to use inert mines or targets as test targets because they represent the local threat. Minelab recommends that the detector always be first tested with the supplied GPR Test Target before local test targets are used for testing.



The Minelab MDS-10 GPR Test Target

GPR Test Target Procedure

1. Bury the GPR Test Target level with the ground surface in a clear, flat section of ground.



2. Ensure GPR Sensitivity is set to 6 (default) (page 39).



3. Perform the Skyshot procedure (page 38).

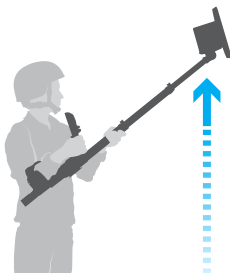

4. Sweep the MDS-10 Sensor Head over the Test Target while adjusting the GPR Sensitivity (page 39).
5. Continue to adjust the GPR Sensitivity until a faint but clear response (a rise in volume) is heard consistently, indicating the GPR Sensitivity level is correct.

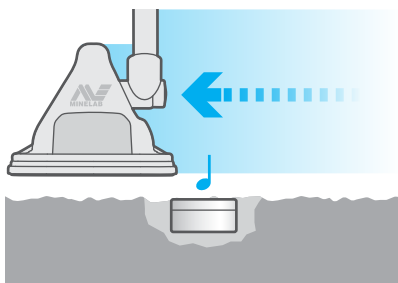

If the Test Target does not produce a response, Factory Reset the detector, and then repeat the Test Target procedure.

! If the Test Target fails to be detected, the detector must be considered faulty and **GPR Mode must not be used.**

The MDS-10 may still be used in MD Sensor Mode.

LCD and LED Indicator Settings

The LCD Screen and Target Indicator LEDs have a range of settings that allow the Operator to detect in high and low light situations.

LCD and LED Brightness

The LCD is dual-mode with a backlight for daytime use and Night Vision Mode for use with NVIS.

The LCD backlight and Target Indicator LED brightness are both adjusted by the Brightness setting, and cannot be adjusted separately.

The Backlight / LED Brightness setting has a range from 1 (low) to 7 (high) with a default setting of 7.

Adjusting the LCD Backlight and LED Brightness

1. From any screen, short-press the Play/Pause button. The Pause Screen will be displayed.



The Play/Pause button

2. Short-press either the Plus (+) or Minus (-) button to display the Brightness adjustment bar at the current brightness level.

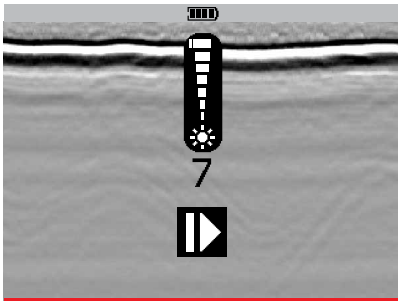

3. Short-press the Plus (+) or Minus (-) buttons to adjust the brightness level.

The Brightness adjustment bar will disappear after 3 seconds of inactivity. Short-press the Pause/Play button to return to the previous screen.

Turn the LCD On or Off

1. To turn the LCD On or Off, long-press the Play/Pause button.



The Play/Pause button

Note: The Target Indicator LEDs will remain on, even if the LCD is turned Off.

Night Vision Mode

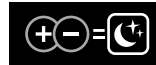

In Night Vision Mode, the LCD Backlight switches to a low intensity mode that is visible only at night with NVIS. The Target Indicator LEDs switch to infrared (IR) which are also only visible with NVIS.



Night Vision Mode Quick Reference on the top right of the User Interface.

To Enable Night Vision Mode:

Note: If Tactical Mode is enabled, Night Vision Mode will already be active. Tactical Mode must be disabled before Night Vision Mode can be enabled separately.

1. Short-press the Plus (+) and Minus (-) buttons simultaneously.  + 
2. The LCD and LEDs will now only be visible to Operators using NVIS.
3. To disable Night Vision Mode and return to the previous LCD/LED setting, repeat step 1.

Note: If powered off whilst Night Vision mode is enabled, the detector will resume operation in Night Vision mode when powered back on.

Sensor Feedback Settings







Sensor Feedback upon target detection is provided via a combination of visual, audio, and tactile (vibration) responses. These combinations can be selected to suit the detecting application and user preference.

The visual, audio, and tactile (vibration) Feedback Settings for each sensor can be independently enabled and disabled via the Setup Screen.

For information on the parts of the Setup Screen and the Setup Pages (General, MD, and GPR), read Setup Screen on page 18.

All Feedback Settings for the MD and GPR Sensors are On by default.

It is recommended that audio feedback for both sensors is enabled, as it is capable of conveying more detection signal information than visual or vibration feedback alone. Visual and vibration feedback is best used to supplement audio.

MD	GPR	Feedback Setting
		Visual (LED) Feedback Setting
		Audio Feedback Setting
		Vibration Feedback Setting

Selecting Sensor Feedback Settings

1. Short-press the Setup button to open the Setup Screen. The General Setup Page options are displayed by default on the Setup Screen.



2. To display the MD Setup Page, short-press the MD button (shown in example)



Or, to display the GPR Setup Page, short-press the GPR button.



The Feedback Settings are displayed as icons (Soft Key Options) along the bottom of the screen.

3. Short-press the button directly below the Feedback Setting icon to enable/disable it.

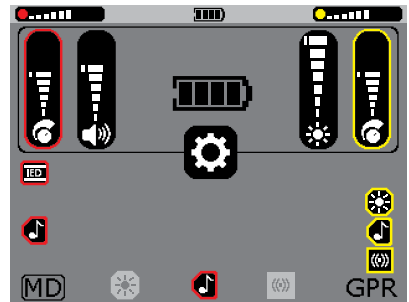

The MD Setup Page showing the Visual and Vibration settings disabled.

Note: At least one Feedback Setting must and will always be enabled.

4. When the selections have been made, short-press the MD button to return to the General Setup Page, or short-press the Setup button to return to the Detect Screen.

Visual Feedback

Visual feedback is provided in the form of two LED bar indicators that display a visual indication of MD and GPR received signal strength.

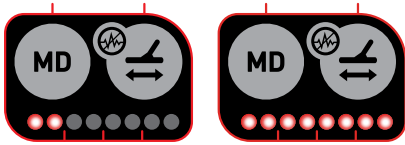

Target Indicator LEDs show a weak received signal

Target Indicator LEDs show a strong received signal

The LED indicators provide both visible light and non-visible IR indication for both sensors, allowing Operators to use NVIS when necessary.

Audio Feedback

Audio feedback should be the primary feedback used by Operators as it is capable of conveying more detection signal information to an Operator than visual or vibration feedback. Skilled Operators can typically achieve higher detection performance using audio feedback than visual or vibration feedback alone.

The MD and GPR Sensors have distinctly different audio tones for easy differentiation. Audio is able to be emitted from both the speaker located on the back of the User Interface, and/or through an earset.

For information on use of the supplied earset and other audio accessories, read Detector Audio on page 27.

Vibration Feedback

Vibration feedback is provided by a vibration motor located in the handle of the detector.

The intensity and duration of vibration feedback is proportional to that displayed by the Target Indicator LEDs.

Tactical Mode

Tactical Mode is provided as a quick means of configuring the detector settings for use in tactical deployment situations.

When Tactical Mode is enabled, the user interface does the following:

- Disables speaker audio (earset audio will remain On if an earset is connected)
- Sets the LCD and Target Indicator LEDs to Night Vision Mode, i.e. LCD and the Target Indicator LEDs are only visible using NVIS.
- Enables vibration feedback.

Enabling Tactical Mode

1. Short-press both the Trigger button and Setup button simultaneously to enable.

To disable Tactical Mode, press both the Trigger button and Setup button simultaneously again.



Tactical Mode Quick Reference on the top right of the User Interface.

To Enable Tactical Mode when powering on the detector

1. When the detector is Off, press and hold the Trigger button and Setup button.
2. Wait until two short vibration pulses have been felt. These occur approximately 2 seconds apart.
3. Release the Trigger button and Setup button.

The detector will be On with Tactical Mode enabled.

User Interface Feedback

User Interface Feedback responses (e.g. a confirmation 'beep' when a button is pressed) will occur according to the enabled sensor feedback settings. To prevent user interface feedback of a particular type, e.g. audio, the Audio Feedback setting must be disabled for both the MD and GPR Sensors.

Detector Audio

The MDS-10 is compatible with a number of Audio accessories.

Volume

The MDS-10 has a single Volume control adjusting MD, GPR and user interface audio responses.

The Volume setting has a range from 1 to 10 with a default setting of 6.

Adjusting the Volume

1. From the Detect Screen, short-press either the Plus (+) or the Minus (-) button to display the Volume adjustment bar.

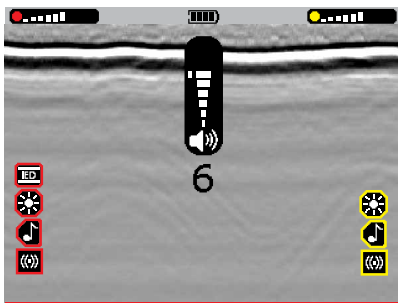

2. Short-press the Plus (+) or Minus (-) buttons to increase or decrease the Volume level.

The Volume adjustment bar will disappear after 3 seconds of inactivity.

Audio Output Modes

MDS-10 has 3 Audio Output Modes:



Speaker Auto-Mute (Default)



Speaker and Earset On



Speaker Off

Speaker Auto-Mute (Default)



Speaker audio is automatically On if an earset is not connected. Speaker audio is automatically muted (Off) if an earset is connected.

Speaker and Earset On



Both the Speaker and the earset are On. This is a useful mode for training scenarios.

Speaker Off



Speaker audio is always Off, even if there is no earset connected.

Note: Speaker Off mode overrides the MD and GPR enabled audio settings.

Selecting the Audio Output Mode

1. Short-press the Setup button to display the Setup Screen. The General Setup Page Soft Key Options will be displayed along the bottom of the screen.
2. Short-press the Plus (+) button (directly below the Audio Output icon). The Audio Output Mode icon will change to the next Mode.

Each short-press of the Plus (+) button will select the next Audio Output Mode.

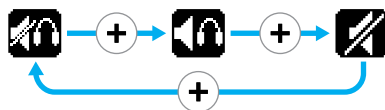

3. Short-press the Setup button to return to the Detect Screen.

MDS-10 Earset Audio

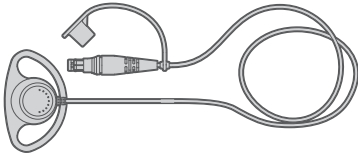

The MDS-10 earset has a unique connector that is compatible with the earset connector on the control box.

The MDS-10 earset is not waterproof when disconnected from earset connector on the control box.

To prevent dirt ingress, apply the dust cap when not in use.

Connecting the MDS-10 Earset

1. Remove the dust caps from both the earset connector on the detector, and from the earset plug on the earset.
2. Ensure that the plug aligns with the connector.
3. Press the earset plug evenly and firmly onto the earset connector.

3.5 mm (1/8") Audio Adapter Cable

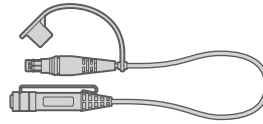

The 3.5 mm (1/8") adapter is an optional accessory for connecting standard 3.5 mm (1/8") headphones to the MDS-10.

The audio adapter cable is not waterproof.

To prevent dirt ingress, apply the dust cap when not in use.

Connecting the 3.5 mm (1/8") Adapter Cable

1. Remove the dust cap from both the earset connector on the detector, and from the plug on the adapter cable.
2. Ensure that the plug aligns with the connector.
3. Press the earset plug evenly and firmly onto the earset connector.
4. Connect any set of headphones with a 3.5 mm (1/8") connector.

Personal Role Radio Adapter Cable

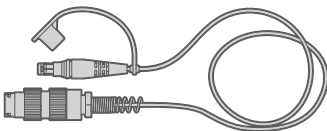

The Personal Role Radio Adapter Cable is an optional accessory. When connected to the MDS-10 Earset connector, it directs audio to the secondary input on the dual switch variant of the 'H4855' Soldier Personal Role Radio headphone. This allows the Operator to monitor the radio whilst also receiving detector audio feedback.

The Personal Role Radio Adapter Cable is not waterproof when disconnected from the earset connector on the control box.

To prevent dirt ingress, apply the dust cap when not in use.

Connecting the Personal Role Radio Adapter Cable

1. Remove the dust caps from both the Earset connector on the detector, and from the Earset plug on the Adapter Cable.
2. Ensure that the plug aligns with the connector.
3. Press the Adapter Cable plug evenly and firmly onto the Earset connector on the MDS-10.
4. Connect the end of the Personal Role Radio Adapter Cable (M55116 circular connector) to the secondary input on the Dual Switch Variant of a H4855 Soldier Personal Role Radio.

MD Sensor Overview

The MD Sensor detects metal (conductive) objects.

Enabling the MD Sensor

MD

The MD Sensor is enabled and disabled by long-pressing the MD button.

All MD related functions are colour coded red for quick recognition.

When the MD Sensor is enabled, the MD Sensor Modes can be accessed. These Sensor Modes are unavailable when the MD Sensor is disabled.

The 3 available MD Sensor modes are:

- Detection Mode (page 30)
- Pinpoint Mode (page 30, page 50)
- Interrogation Mode (page 30, page 51)



Detect Screen with the MD Sensor enabled.

MD Trace

When the MD Sensor is enabled, the red MD Trace at the bottom of the Detect Screen is displayed. The MD Trace visually displays the responses from metallic targets.

Data scrolls in real-time across the screen from right to left. The image represents 4 seconds of data, with the left representing data from 4 seconds ago. The most recent data is displayed on the right.

The size of peaks on the MD Trace is proportional to received target signal strength, similar to the Target Indicator LEDs.

Weak target detections will produce small variations in the MD Trace. Strong target detections will produce large peaks in the MD Trace.

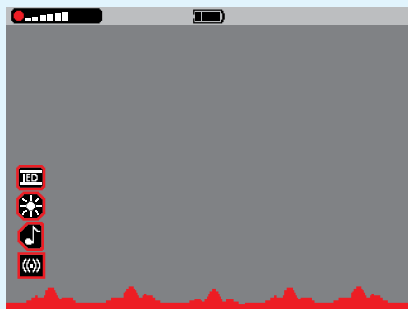

Small or deep metallic targets

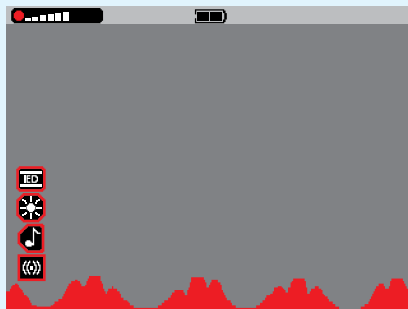

Large or shallow metallic targets

MD Sensor Modes

Detection Mode (Default)

Detection Mode is optimised for maximum detection performance, and is the default MD Sensor Mode used for initial searching of new ground to detect targets.

In Detection Mode, the detection signal is dynamically processed, meaning the Sensor Head must be moving relative to the target (e.g. using a normal sweeping search technique) in order to register a detection response.

In Detection Mode, audio target responses have pitch and volume that is proportional to received target signal strength. Strong targets will be loud/high-pitched and weak targets will be quieter/low-pitched.

Detection Mode is optimised for target detection and is more sensitive than Interrogation Mode or Pinpoint Mode. Therefore, very small targets detected in Detection Mode may not be detected when using Interrogation Mode or Pinpoint Mode. If this occurs, use Detection Mode to pinpoint a detected target, rather than using Pinpoint Mode.

Pinpoint Mode

Pinpoint Mode provides a static response such that target feedback will be heard even if the Sensor Head is stationary with respect to the target. This mode is useful for locating targets.

To enable Pinpoint Mode, press and hold the Trigger button.

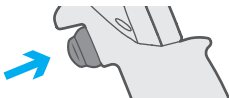

When the Trigger button is released, the MD will return to Detection Mode.

Pinpoint Mode is used to map a detected metal target to discover its size and shape. For detailed information on mapping a target using Pinpoint Mode, see page 50.

Pinpoint Mode can also be used to locate the centre of a target. For detailed information on locating the centre of a target using Pinpoint Mode, read page 50.

Interrogation Mode

Interrogation Mode provides additional information regarding the probable characteristics of a target based on its response to the magnetic field transmitted by the MD, including:

- Apparent target conductivity.
- Whether the target is ferrous or non-ferrous.
- Whether the target is potentially a carbon rod switch component.

In Interrogation Mode, audio responses consist of a single 'beep' tone where the pitch corresponds to the characteristics of the detected target.

- Ferrous targets sound very low-pitched.
- Carbon Rod targets sound very high-pitched.
- Non-Ferrous targets will have a mid-range pitch response where the pitch is proportional to the conductivity of the target.

To enable/disable Interrogation Mode, press and release the Trigger button.

For detailed Interrogation Mode operation information, see page 51.

MD Sensor Overload

When operating any of the MD Modes (Detection/ Pinpoint/ Interrogation), very large metal objects close to the Sensor Head may overload the detector's electronics.



If this occurs, the Coil Overload icon will flash on the LCD, and the Overload Alarm will repeat until the Sensor Head is moved away from the source of the overload.

Overloading is not harmful to the electronics of the detector.

MD Ground Balance

MD Ground Balance reduces noise caused by ground mineralisation, allowing targets to be detected more clearly.

The MDS-10 is capable of detecting metallic objects in all ground conditions. During the Ground Balance procedure, the detector learns and adapts to the ground characteristics to reduce ground noise and false alarms due to mineralised (magnetic/lateritic) soils.

Frequent Ground Balancing will ensure maximum detection performance.

Ground Balance must be performed every time the detector is powered On.

It is recommended that Ground Balance be repeated:

- When ground conditions change.
- When it is suspected that the detector is responding to the ground.

The MDS-10 uses a fixed Ground Balance system that will only change during a user-initiated Ground Balance procedure. The MDS-10 will not automatically adjust to different ground during detecting.

MD Sensor Calibration

The MD Sensor calibration occurs for approximately 5 seconds after the MDS-10 is powered On.

During MD start-up calibration, the first MD Target Indicator LED will flash. When the LED stops flashing and remains static on, a Ground Balance can be initiated.



If Ground Balance is attempted before the start-up MD calibration is complete (i.e. first MD Target Indicator LED is flashing), an invalid button press tone will sound.

MD Ground Balance Procedure

1. Ensure this procedure is carried out on ground that contains no metal targets, and is representative of the ground in the intended search area.

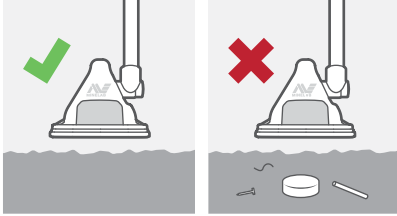

2. From the Detect Screen, with the MD Sensor enabled, short-press the Ground Balance button to initiate the Ground Balance process.



The Ground Balance button

A flashing Ground Balance icon will appear on the LCD, indicating that Ground Balance is in progress.

Ground Balance can be cancelled by pressing the Ground Balance button again.

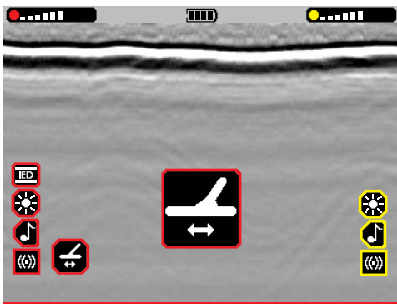

3. Sweep the coil left and right across the metal target free ground, maintaining a sweep height of 25–50 mm (1–2").

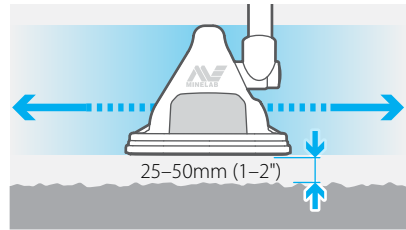

4. After eight seconds, there will be a confirmation tone/vibration, the flashing Ground Balance icon will disappear, and the detector will return to Detection Mode.
5. Sweep the coil back over the metal free ground checking for any ground noise or false alarms. Repeat Ground Balance if required.

Successfully completing Ground Balance may allow the use of a higher MD Sensitivity level due to reductions in ground noise and false alarms.

Ground Balance Mode

The MDS-10 has two Ground Balance Modes:



IED Mode (Default)



Conventional Mode

IED Mode (Default)



The IED (Improvised Explosive Device) Mode for the MD Sensor is the default and recommended mode for most detecting operations.

IED Mode is sensitive to high frequency IED-like targets such as wires, carbon rods, and very fine metal parts. IED Mode can also be more susceptible to naturally conductive elements in the environment, such as charcoal fragments or salt (e.g. wet beach sand adjacent to seawater). In such scenarios Conventional Mode can be used.

Conventional Mode



The Conventional Mode behaves more like a conventional mine detector such as the Minelab F3. It is less sensitive to high frequency objects such as wires, carbon rods and charcoal. It maintains a high sensitivity to metal targets typically detectable by conventional metal detector technologies.

Conventional Mode can be used for beach locations.

Selecting an Appropriate Ground Balance Mode

Use of IED Mode is recommended except:

- When detecting on wet sand at a seawater beach or other salt environment,
- When detecting in an area known to be contaminated with charcoal fragments, fine wire or metal fragments, or
- If, after performing a Noise Cancel and Ground Balance, the MD Sensor still gives a high number of false alarms with an MD Sensitivity setting of 4 or lower in IED Mode.

In these scenarios, Conventional Mode may give better performance.



WARNING: Conventional Mode is less sensitive to certain IED threats including wires and carbon rod switch components. The Operator must always take the threat environment into account when deciding on a suitable Ground Balance Mode.

Selecting the Ground Balance Mode

1. From the Detect Screen, short-press the Setup button. The Setup Screen will be displayed.



The Setup button

2. Short-press the Ground Balance button (directly below the Ground Balance Mode icon).



The Ground Balance button

The Ground Balance Mode icon will change to the next Ground Balance Mode.

Each short-press of the Ground Balance button will toggle between the two available Search Profiles.

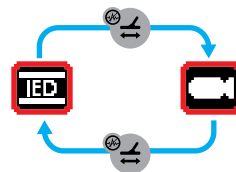

MD Noise Cancel

MD Noise Cancel adjusts the MD Sensor to reduce electrical interference.

Detectors may become noisy due to electrical interference from power lines, electrical equipment, or other detectors operating nearby. The detector interprets this interference as inconsistent, erratic detections, even when the detector is held stationary.

MD Noise Cancel Procedure

1. Hold the Sensor Head stationary and away from the ground and metal targets.

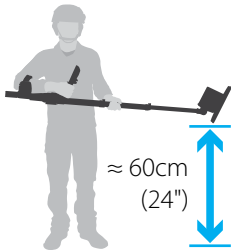

2. From the Detect Screen, with the MD Sensor enabled, long-press the Ground Balance button to initiate the Noise Cancel process.



The Ground Balance button

3. The Noise Cancel icon and progress bar will be shown on the LCD. A tone and/or vibration indicates that Noise Cancel is in progress.

Do not use the detector whilst Noise Cancel is in progress.



4. After 25 seconds, there will be an audio tone when the Noise Cancel is complete. The progress bar will reach 100%, and the icon and progress bar will disappear.

Nearby Detectors Procedure

If operating in close proximity with other detectors and there is interference, the following procedure should be followed:

1. Enable the MD Sensor on all detectors.
2. Perform Noise Cancel on each detector, one at a time to ensure that each detector selects a different operating frequency.
3. Perform Ground Balance on each detector after Noise Cancel, before commencing detecting.

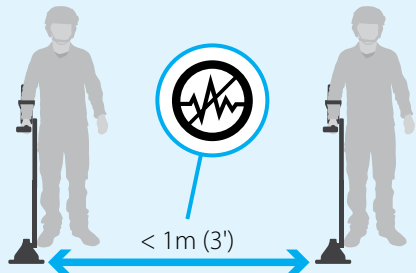

MD Sensitivity

MD Sensitivity should be adjusted as needed to reduce false alarms arising from difficult grounds.

The MD Sensitivity setting has a range from 1 (low) to 10 (high) with a default setting of 6.

To avoid missing targets, always set the sensitivity to the highest setting which does not give excessive false signals when the Sensor Head is swept over ground which is free of targets. This setting will depend on the ground being searched, and how well the detector has ground balanced to the soil.

The MD Sensitivity level is displayed visually in the LCD Status Bar at all times when the MD Sensor is enabled.



When viewing the Setup Pages or when adjusting the MD Sensitivity, the sensitivity level is displayed as a vertical gauge.

There is a default setting marker at level 6 to indicate the default sensitivity position.

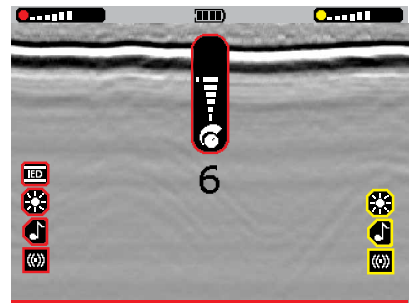

Setting the MD Sensitivity

1. Ensure that the MD Sensor is enabled, and the Detect Screen is active.
2. Ensure the MD Sensor has been Ground Balanced, and (if required) perform a Noise Cancel.
3. Short-press the MD button to display the MD Sensitivity Adjustment Bar and value.

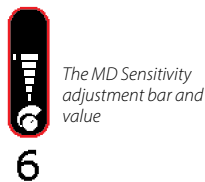

While sweeping the Sensor Head over ground with no targets present, use the Plus (+) button to increase the Sensitivity until false signals begin to occur.

4. Reduce the Sensitivity by pressing the Minus (-) button, just enough that these false signals disappear.

Note: The Sensitivity adjustment bar will time-out (disappear) after 3 seconds of inactivity.



It is the responsibility of the Operator to test and ensure that the chosen sensitivity setting is safe and correct before beginning live operations.

Where practical the Operator should bury an FFE (Free From Explosive) target that represents the local threat to confirm the detector and the sensitivity setting is correct.

GPR Sensor Overview

The GPR Sensor is capable of detecting both metallic and non-metallic targets as well as ground anomalies (clutter).

Enabling the GPR Sensor

GPR

The GPR Sensor is enabled and disabled by long-pressing the GPR button.

All GPR related functions are colour coded yellow for quick recognition.

When the MDS-10 is powered On, the GPR Sensor is not operational (i.e. GPR imagery is not shown) until a Skyshot is performed, even if the GPR Sensor is enabled.

When the GPR Sensor is enabled, Advanced GPR settings can be accessed and modified. They are unavailable when the GPR Sensor is disabled.

These advanced settings are:

- GPR Start/Stop Gates (page 40)
- GPR Detection Threshold (page 41)

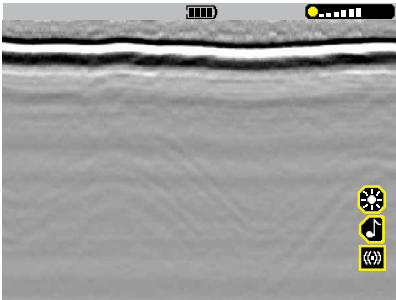

Detect Screen with the GPR Sensor enabled.

GPR Standby Mode

The MDS-10 GPR sensor will automatically enter standby mode when the detector has not been moved or swung for 8 seconds.

The GPR will stop transmitting GPR signals and the detector will not detect GPR targets.

As soon as the MDS-10 is moved or swung, normal GPR operation will commence.

The MD Sensor will continue to operate unaffected by the GPR Standby Mode.

A GPR standby icon is displayed in the status bar when the MDS-10 is in Standby Mode.

GPR Skyshot

Skyshot is a calibration to remove the GPR's own radar signature from the GPR system for clearer imagery and optimum detection performance.

The GPR Sensor requires a Skyshot procedure before each use, and cannot be operated and no GPR Imagery (page 43) will be generated until this is performed.

In addition, a Skyshot should be repeated:

- If the Skyshot icon is flashing on the LCD.
- After each hour of continuous operation, indicated by the small flashing Skyshot icon.
- After the Sensor Head angle or rotation or shaft length has been adjusted.
- If the GPR target audio feedback becomes noisy or;
- If horizontal 'bands' or other visual indications can be seen in the GPR image with the Sensor Head raised away from the ground.

GPR Sensor Calibration

The GPR Sensor calibration occurs for approximately 15 seconds after the MDS-10 is powered On. During GPR start-up calibration, the first GPR Target Indicator LED will flash. When the LED stops flashing and remains static on, a Skyshot can be initiated.

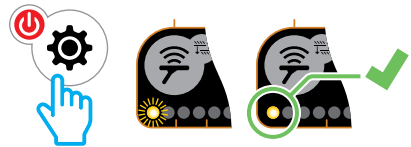

If Skyshot is attempted before the start-up GPR calibration is complete (i.e. first GPR Target Indicator LED is flashing), an invalid button press tone will sound.

GPR Skyshot Procedure

1. Ensure that the GPR Sensor is enabled, then raise the Sensor Head high up in the air, away from all objects.

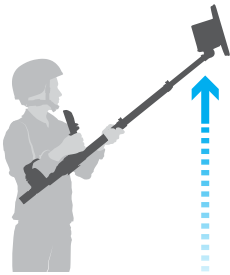

2. Short-press the Skyshot button to initiate the Skyshot process..



The Skyshot button

A flashing Skyshot icon will appear on the LCD, indicating that the Skyshot is in progress.



3. Continue to hold the detector stationary until a vibration and confirmation tones indicate that Skyshot is complete (approximately 2–3 seconds).

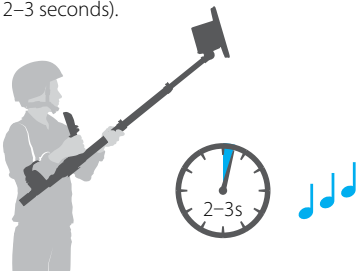

4. The GPR Image should appear clean without any objects visible. If the GPR image is degraded or horizontal bands are present (when the detector is still raised), repeat the above steps until a clean GPR image is achieved.



Clean Skyshot: minimal background noise/EMI is visible.

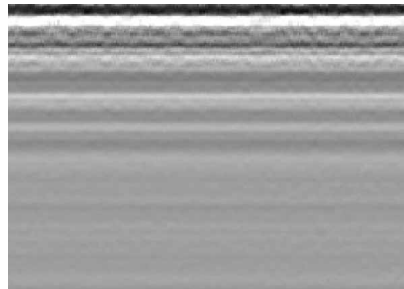

Bad Skyshot: horizontal bands are present in the GPR Imagery when the detector is still raised.

GPR Sensitivity

GPR Sensitivity should be adjusted as needed to reduce false target signals in more difficult grounds.

The GPR Sensitivity setting has a range from 1 (low) to 10 (high) with a default setting of 6.

Increasing sensitivity will increase the likelihood that targets (and clutter) will cause audio feedback and overlay highlights on the display. This is done according to a specific profile that increases with depth. Deeper targets will be amplified more relative to shallow targets as sensitivity is increased.

To avoid missing targets, always set the sensitivity to the highest setting which does not give excessive false signals (audio, visual, or vibration) when the Sensor Head is swung over ground that is free of targets. This setting will depend on the ground being searched and other conditions, such as soil moisture content.

The GPR Sensitivity level is displayed visually in the LCD Status Bar at all times when the GPR Sensor is enabled.



The GPR Sensitivity Level Indicator in the Status Bar

When viewing the Setup Pages or when adjusting the GPR Sensitivity, the sensitivity level is displayed as a vertical gauge.

There is a default setting marker at level 6 to indicate the default sensitivity position.

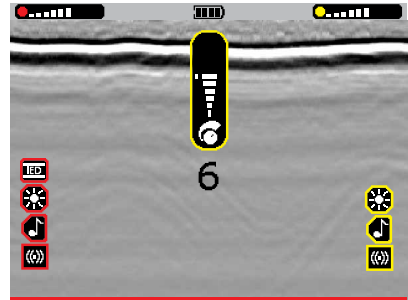

Setting the GPR Sensitivity

1. Ensure that the GPR Sensor is enabled, and the Detect Screen is active.
2. Short-press the GPR button to display the GPR Sensitivity adjustment bar and value.



6

3. While sweeping the Sensor Head over ground that is free of targets, use the Plus (+) button to increase the Sensitivity level until false signals begin to occur.
4. Reduce the Sensitivity level by pressing the Minus (-) button, just enough that these false signals disappear.

Note: The Sensitivity adjustment bar will time-out (disappear) after 3 seconds of inactivity.



It is the responsibility of the Operator to test and ensure that the chosen GPR Sensitivity setting is safe and correct before beginning operations.

The GPR Test Target or FFE (Free From Metal) target should be buried and then detected to confirm the suitability of GPR Sensitivity settings. (See GPR Test Target Procedure on page 23).

Advanced GPR Settings

The advanced GPR settings allow fine tuning of the GPR detection capability.

GPR Start/Stop Gates

The GPR Start/Stop Gate Function allows the Operator to mask detections from layers of soil near the surface, and at the bottom of the detectable depth range.

This helps to eliminate unwanted false alarms from rough or uneven soil surfaces, and shallow or very deep layers of clutter in the soil.

The Start and Stop Gates are adjusted independently.



The Start Gate has a range from 0 to -100 with a default setting of 0.

The Start Gate can be set to suppress detections from targets and clutter that appears above the Start Gate Marker. This reduces false alarms due to rough or uneven ground, or clutter layers near the surface, such as grass or layers of leaf matter. The grey GPR imagery will still be displayed, but audio, LED and vibration responses and red overlay highlights will be suppressed for targets or clutter above the Start Gate marker. Note that this setting will also suppress detection responses from flush or shallow buried targets, and should only be used when necessary.



The Stop Gate has a range from -100 to 0, with a default setting of -100.

The Stop Gate can be set to suppress detections from targets and clutter that appear below the Stop Gate marker. This may be useful to suppress responses from deep clutter layers. The Grey GPR imagery will still be displayed, but audio, LED and vibration feedback, and red display overlay markings will be suppressed below the Stop Gate marker.

Setting the Start/Stop Gates

1. Ensure that the GPR Sensor is enabled, then long-press the Skyshot button.



The Skyshot button

The Start Gate icon and numerical value will be displayed. Markers will flash on the left and right of the LCD, indicating which Gate is currently being adjusted.

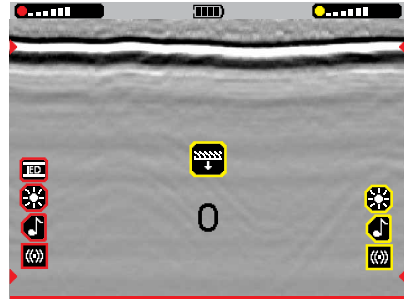

2. Use the Plus (+) and Minus (-) buttons to increase or decrease the Gate position. The markers will move correspondingly.

Repeat as necessary while sweeping the Sensor Head over the type of ground to be searched until false alarms no longer occur.
3. Short-press the Skyshot button to proceed to the Stop Gate adjustment.
4. Repeat step 2 to adjust the Stop Gate.

The Gate positions cannot be overlapped, so a value lower than the Start Gate value must be selected.

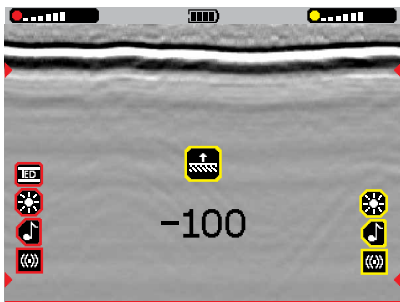

5. Short-press the Skyshot button to proceed to GPR Detection Threshold adjustment (page 41).

Each short-press of the Skyshot button will cycle back through the Start Gate, Stop Gate, and GPR Detection Threshold settings.

6. Long-press the Skyshot button to return to the Detect Screen.

The Start and Stop Gate markers will remain on the Detect Screen for reference, but will not be displayed on the Detect Screen if they are set to 0 or -100.

GPR Detection Threshold

The GPR Detection Threshold setting adjusts the threshold at which the GPR will give a detection response (audio, vibration, LED, and red GPR overlay) for weak targets in the GPR Imagery.



The GPR Detection Threshold setting has a range from 0 to 100 with a default setting of 30.

A higher GPR Detection Threshold setting will result in more detection feedback for weaker targets, but also more false alarms due to ground clutter.

A lower GPR Detection Threshold setting will reduce false detections due to ground clutter, but will also result in less detection feedback for weaker targets.

Note that GPR Detection Threshold works similarly to GPR Sensitivity, however it applies the same

to targets and clutter at all depths, rather than proportionally increasing with depth, as GPR Sensitivity does.

Adjusting GPR Detection Threshold

1. With the GPR Sensor enabled, long-press the Skyshot button. Start Gate adjustment will be displayed.



The Skyshot button

2. Short-press the Skyshot button twice to display GPR Detection Threshold adjustment.

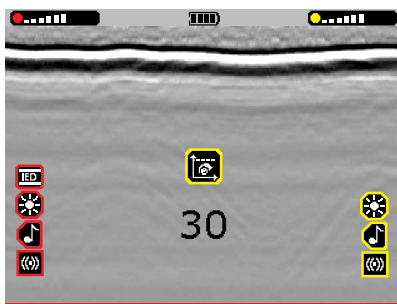

Each short-press of the Skyshot button will cycle through the Start Gate, Stop Gate, and GPR Detection Threshold settings.

3. Use the Plus (+) and Minus (-) buttons to increase or decrease the GPR Detection Threshold level.
4. Long-press the Skyshot button to return to the Detect Screen.

Play/Pause

The GPR Imagery and/or MD Trace can be paused if an anomaly of interest is observed. This pauses the GPR Image and MD Trace (see page 29) so it can be scrutinised.

It also disables the transmitters for both MD and GPR Sensors.

Pause the GPR Imagery/ MD Trace

1. Short-press the Play/Pause button while detecting.



The Play/Pause button

The imagery will pause, and the Pause/Play icon will flash on the LCD.

All Sensor Feedback Setting Icons and Sensitivity Level Indicators will be temporarily hidden.

The MD and GPR Sensors will be temporarily disabled.

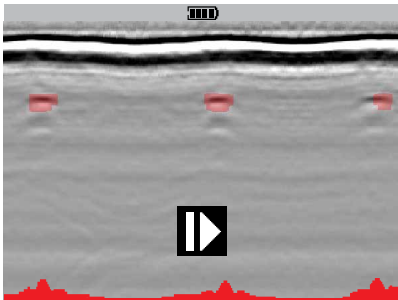

2. Short-press the Pause/Play button again to re-enable the Sensors and restart GPR imagery and/or MD Trace generation.

GPR Imagery Overview

Understanding GPR Imagery is a learned skill. Below are the basic fundamentals of GPR imagery interpretation.

The MDS-10 has a unique visual representation of subsurface imagery. This allows the Operator to distinguish anomalies visually, as well as audibly. Visual interpretation is based on soil composition, size, shape and density of the anomaly.

Basics of GPR Imagery

The MDS-10 displays GPR raw data which shows an image of buried objects and sub surface structures. Data scrolls in real-time across the screen from right to left (4). The image represents 4 seconds of data, with the left representing data from 4 seconds ago. The most recent data is displayed on the right.

Shallow buried objects (close to Sensor Head) will be displayed near the top of the image and deep buried objects are displayed lower in the image.

Parts of the GPR Imagery

Note: GPR imagery varies with type, density and moisture content of soil.

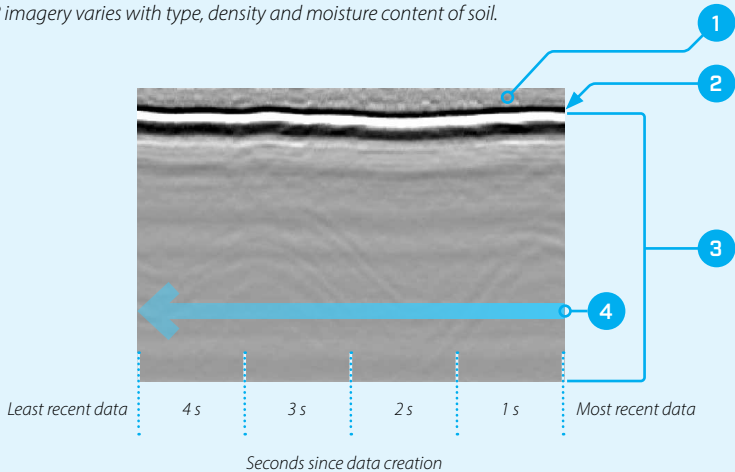

1. Air

The space from the bottom of the Sensor Head to the surface of the ground.

2. Ground surface response

The most prominent (dark and light) lines show the ground surface response.

3. Area under ground

Everything below the ground bounce line is displaying what is in the ground.

4. Data Flow

Arrow shows the direction of data flow across the screen from right to left.

Detection GPR Imagery

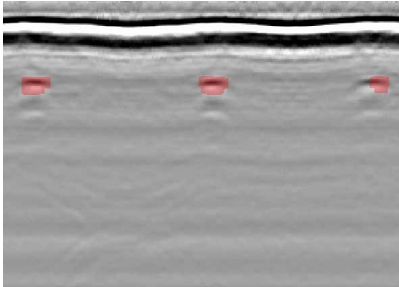

The GPR Image shows a typical detection. Anomalies are overlaid in red to facilitate recognition.

Noisy GPR Imagery

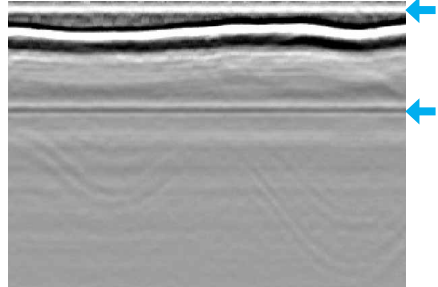

The GPR Image is noisy, making it difficult to identify true target signals among the erratic detections. Note the straight horizontal bands in the image, including above the ground surface. Skyshot procedure is required.

Deep and Shallow Anomaly Imagery

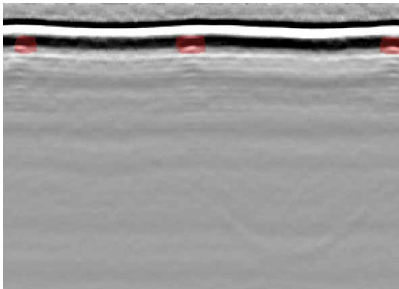

Small, shallow buried object detected.

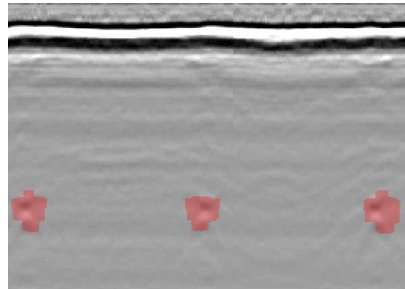

Deep buried object detected.

Detection Sweep-Speed Effect

The Operator can sweep the detector slowly or quickly, up to approximately 1 metre (3-feet) per second.

Sweeping the Sensor Head quickly will compress the visual image on the display. Sweeping the Sensor Head slowly will elongate the visual representation of the anomaly.

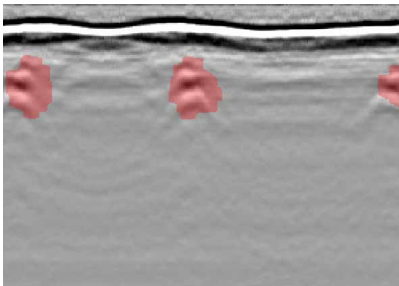

Large target detection with a fast sweep-speed. The imagery becomes compressed across the time period.

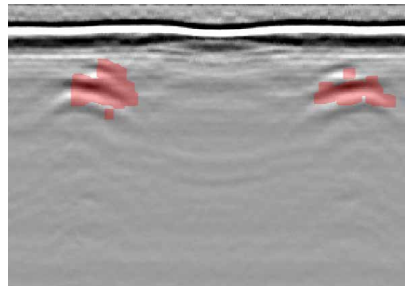

The same target detected with a slow sweep-speed. The imagery becomes elongated across the time period.

Common Ground Type Imagery

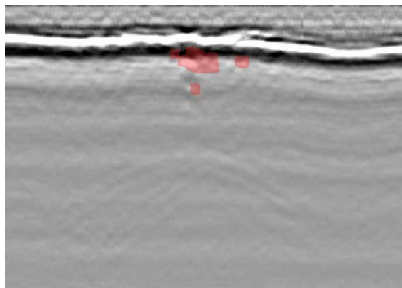

Shallow target detected under a grass surface. Note the irregular surface response due to the grass surface.

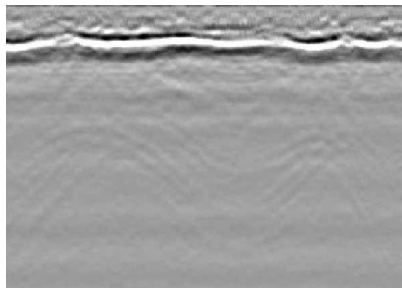

GPR Imagery detected over a surface layer of leaves and bark. Note the irregular surface response due to the leaves and bark in the surface layer.

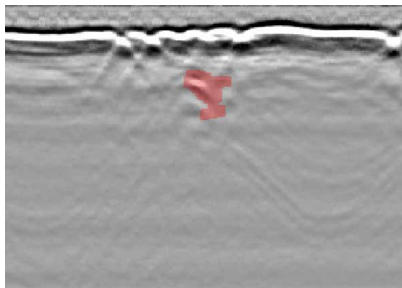

Target detected beneath an uneven surface layer.

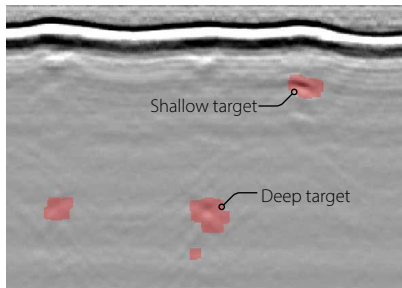

GPR Imagery showing adjacent deep and shallow targets.

Search Technique

Using the correct search technique is crucial for optimum detecting.

Search Speed

The detector should be swept with a smooth even motion at a speed between 0.5 to 1 metre/sec (1.5' to 3' sec). If the detector is swept too fast or too slow small or deep targets may be missed.



Search Overlap

It is standard operating procedure to use a half coil overlap when sweeping, to ensure full ground coverage.

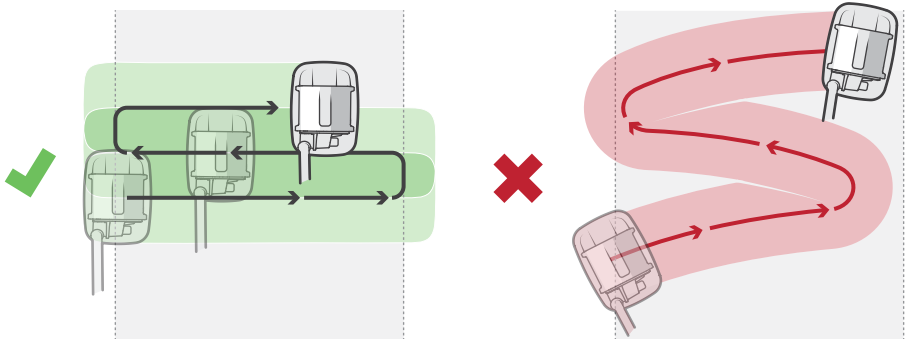

Search Height

To minimise false alarms, ensure that the Sensor Head is swept as parallel to the ground as possible, at a height of approximately 25–50 mm (1–2").

Sweeping the Sensor Head closer than 25–50 mm (1–2") is recommended when only the MD Sensor is operating.

The GPR Sensor should optimally be operated no closer than 25 mm (1") above the ground to avoid ground coupling. Ground coupling is the interaction between the GPR transmitter and the receiver, which results in clutter and noise in the GPR Imagery.

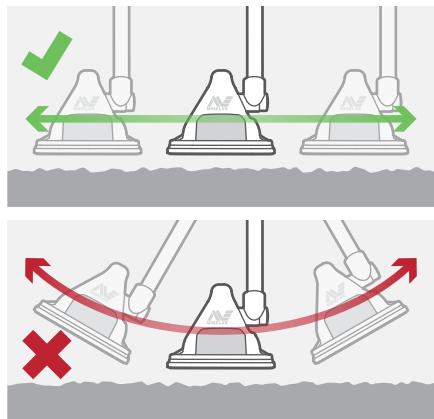

Locating the Target

Target location techniques narrow down the exact location of a target.

Mapping the Target

Mapping a detected target is an important procedure that will allow the Operator to immediately gain an impression of the approximate location, size, and type (e.g. MD or GPR) of the target.

Mapping the target also confirms that the target is not in close proximity to a second target.

This procedure is effective for mapping targets with both GPR and MD enabled (in Detection Mode). For the MD, there are additional techniques that can be used to locate metal targets more accurately. See MD Edge Mapping Procedure on page 49, and MD Pinpointing Procedure on page 50.

Target Mapping Procedure

1. Maintaining the standard sweeping technique, sweep the Sensor Head over and beyond the target in an attempt to find clear ground.

With each sweep, the MD Trace (or GPR Imagery) will display the strongest signal when the Sensor Head is in close proximity to the target.

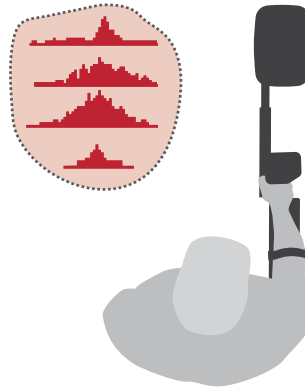
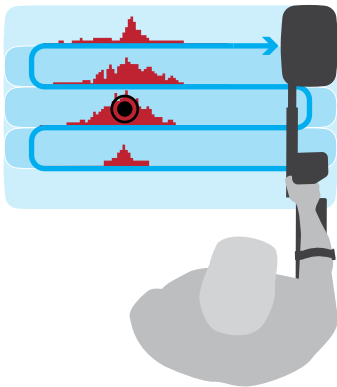

Once the Operator has obtained an approximate idea of the size, relative depth, and metallic content of the target, greater target accuracy can be achieved.

Use the MD Edge Mapping (page 49) and/or MD Pinpointing (page 50) procedures to more accurately locate the target.

2. Form a mental image of the approximate bounds of the target.

MD Search Tips

Sensor Head Orientation

Always approach targets to be located/mapped/pinpointed with the long sides of the Sensor Head.

Never use the back and front of the Sensor Head to approach a target, as the target may not be detected, or may be inaccurately located.

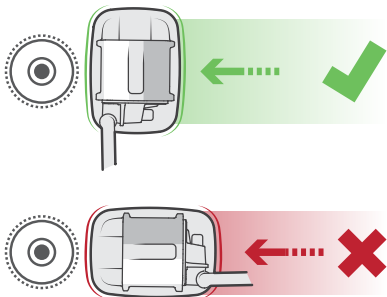

Pinpoint Mode Target Feedback



Activating Pinpoint Mode alters the manner in which the metal detector operates.

Detection Mode gives a dynamic response i.e. the Sensor Head must be moving over a target in order to detect it.

When Pinpoint Mode is selected, it changes to a 'static' response. This means that the detector will give target feedback when the Sensor Head is stationary/moving very slowly over a target. This assists in finely pinpointing the location of a target.

Sensor Head Null Zone

If a target contains metal, the MD audio response increases to the maximum pitch when the Sensor Head is immediately adjacent to the target centre (on both sides), with a 'null zone' precisely centred over the target.

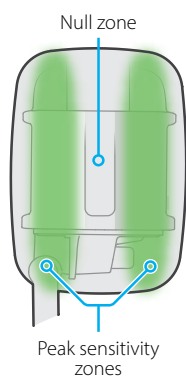

Sweeping over a target with MD Pinpoint Mode enabled will produce a 'double-beep' response due to a characteristic of the MD figure-8 receive coil.

The coil has a precise null down the length of the centre of the coil (and corresponding peak sensitivity areas either side).

MD Detection Mode can produce a 'triple-beep' response because it is a dynamic mode that is motion-dependent.

MD Pinpoint Mode is a static mode resulting in a 'double-beep' which reflects the sensitivity pattern of the MD coil.

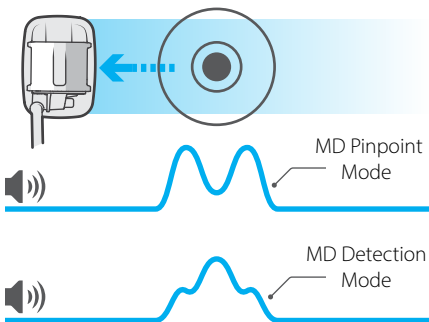

MD Edge Mapping Procedure

The MD edge mapping procedure uses Pinpoint Mode to identify the outer edges of a metal target when only the MD Sensor is enabled.

Note: Pinpoint Mode is slightly less sensitive than Detection Mode, and may not work well for extremely weak target detections. In these instances, use Detection Mode to map the target (steps 2 to 5).



Do not select Pinpoint Mode when the Sensor Head is above the target. This may result in the target being masked.

1. Move the Sensor Head away from the target and enable Pinpoint Mode by pressing and holding the Trigger button.



The Pinpoint icon will appear on the LCD, and the audio responses will change.

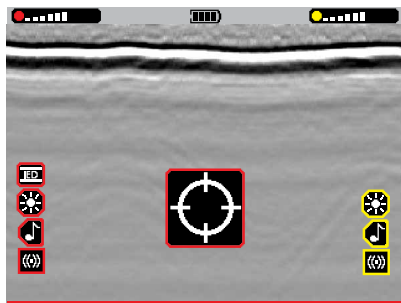

Mapping Multiple Targets

The Operator may find multiple objects of interest in close proximity but may want to locate them separately.

Use the normal target location procedures to determine the locations of multiple targets. An irregular shape may emerge, allowing the centres of individual targets to be pinpointed within it.

2. Move the Sensor Head to approach the target area from a variety of angles.

Do not use the short sides of the Sensor Head (see Sensor Head Null Zone on page 48).

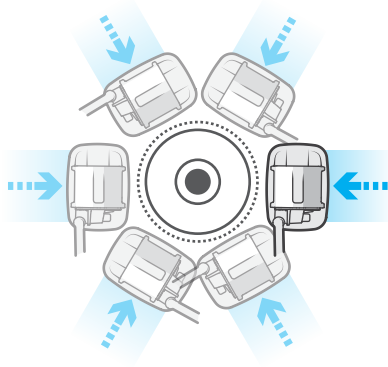

As the Sensor Head approaches the target, the Target indicators will indicate that the target is in close proximity.

3. When there is an audio response, mentally mark the position on the ground.
4. Move the coil away, and approach the target from another angle.
5. This process continues until a clear mental picture of the target size and shape is achieved. The Operator will also be confident that the target is contained in the mapped area.

Once the target has been mapped, Pinpoint the centre of the target (page 50).

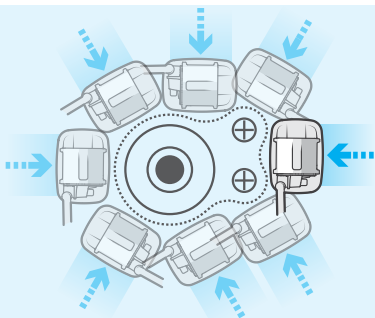

MD Pinpointing Procedure

After the target edges have been mapped, the MD Pinpointing procedure is carried out to precisely determine the centre of the target.

If the target contains metal, and the metal in the target is sufficiently small, the area mapped will also be small, therefore it is easier to identify the centre of the target.

Note: Pinpoint Mode is slightly less sensitive than Detection Mode, and may not work well for extremely weak target detections. In these instances, use Detection Mode to find the centre of the target (steps 2 to 5).

! Do not select Pinpoint Mode when the Sensor Head is above the target. This may result in the target being masked.

1. Move the Sensor Head away from the mapped target and enable Pinpoint Mode by pressing and holding the Trigger button.

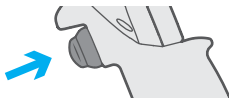

The Pinpoint icon will appear on the LCD, and the audio responses will change.

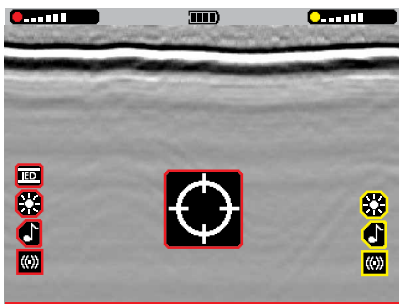

2. Sweep the coil over the target.

If the target contains metal, the MD audio response will increase to the maximum pitch when the sensor head is immediately adjacent to the target centre.

3. When a response is heard, mentally mark the centreline.

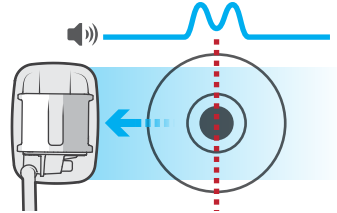

4. Repeat the process with the detector oriented at 90° to the first position. The intersection of the two lines will indicate the target location.

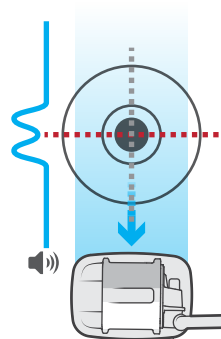

5. To disable Pinpoint Mode and return to Detection Mode, release the Trigger button.

Once the MD target has been Pinpointed, it can be Interrogated (page 51).

MD Interrogation Mode

Interrogation Mode provides information regarding characteristics and composition of a target.

When using the detector in Dual Sensor Mode, the separate MD and GPR signals may be used to differentiate targets of different types.

For example, a large metallic object will generate a high target response from both the MD and GPR, while a large non-metallic object would generate a high target response from the GPR but little to no response from the MD.

Conversely, a very small metallic target may not generate a response from the GPR, but still generate a response from the MD.

Interrogation Mode Audio

MD Interrogation Mode will provide an audio tone related to the target's ferrous content and conductivity. The detection tone in Interrogation Mode is not related to the target size and proximity as it is in MD Detection Mode.

Interrogation Mode Procedure

1. Ensure that the MD Sensor is enabled.
Interrogation Mode cannot be enabled when operating only the GPR Sensor.
2. Press and release the Trigger button once to enable Interrogation Mode.

The Target Identification (ID) Field will be displayed (see page 52 for detailed Target ID information).

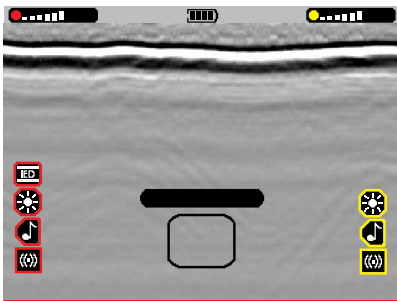

Audio feedback will change; Interrogation Mode audio will vary in tone corresponding to the target composition (see page 30).

A Target ID will also be displayed on the LCD corresponding to the tone emitted.

3. Pass the coil over the target to be interrogated, while paying attention to target feedback and reviewing the Target ID.

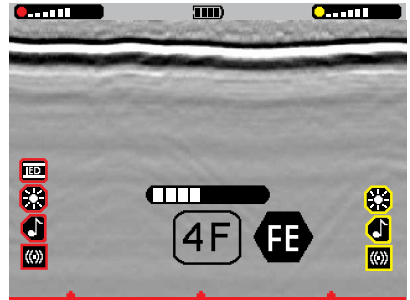

4. Press and release the Trigger button to return to Detection Mode.

Note: Interrogation Mode will provide a specific tone for a target. However, the tone is not unique and other targets may produce the same type of tone. In different types of soil, the same target may give a different tone when interrogated.

MD Target ID

MD Target ID represents the apparent conductivity and likely composition of a target. Target IDs are based on the characteristics of a detected target's response to the magnetic field applied by the MD.

The MD Target ID is an identification displayed in the Target ID Field on the LCD when MD Interrogation Mode is enabled, consisting of a single digit and letter.

The conductivity of a detected target is represented as a dimensionless number from 0 (low conductivity) to 9 (high conductivity). The number is also represented visually on the Conductivity Bar.

The likely material type of a detected target is represented as a letter.

In general, the stronger the target signal strength, the more accurate the Target ID.

Ferrous Targets

If a detected target is ferrous, the letter 'F' is displayed beside the number (0 to 9) inside the Target ID Field, and the Ferrous icon appears on the right.

Ferrous targets give a very low-pitched beep tone in Interrogation Mode.

Non-Ferrous Targets

If a detected target is non-ferrous, a number (0 to 9) is displayed in the Target ID Field, but no letter will be displayed.

Non-ferrous targets give a medium to high-pitched beep tone in MD Interrogation Mode, depending on their conductivity (higher pitch corresponds to higher conductivity).

Low Conductivity Targets

If a detected target has very low conductivity, the letter 'C' is displayed beside the number inside the Target ID Field, and the Carbon Rod icon appears on the left.

Low conductivity targets usually have a Target ID of 0 or 1, and have characteristics consistent with carbon rods or small wires. These can be found in particular types of IED threats.

Low conductivity targets give a distinctive very high-pitched beep tone in MD Interrogation Mode.

Target ID Examples

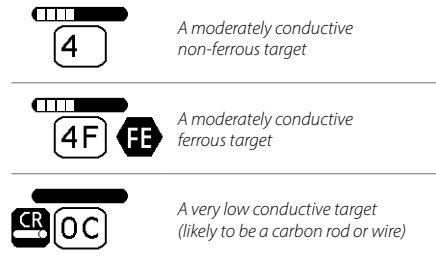

Parts of the Target ID Field

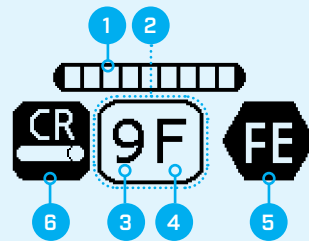

1. **Conductivity Bar (0 to 9)**
2. **Target ID Field**
3. **Target ID Number**
4. **Target Composition Indicator**
F = Ferrous C = Carbon Rod
5. **Ferrous Target Indicator**
6. **Carbon Rod Indicator**

Detector Battery

The MDS-10 detector is powered by a removable, rechargeable lithium-ion battery. There is also an AA battery carrier available.

Battery Status Indicator

The battery status indicator shows the current battery level, and is located in centre of the Status Bar on the LCD.

	75% – 100%
	50% – 75%
	25-50%
	5-25%
	<5% (Flashing, Charging required)

Low Battery Alert

The detector regulates the battery voltage so that its performance remains constant regardless of the charge remaining in the battery.

If the battery level is critically low, the Operator will be alerted in any combination of the following ways:

- If the LCD is On, the battery outline in the status bar will flash rapidly.
- If audio is enabled, there will be a rapid high-low-high-low tone every 10 seconds.
- If vibration responses are enabled, there will be three rapid vibrations every 10 seconds.

When the battery is completely flat, the detector will automatically power Off.



If the Low Battery Alert occurs, the Operator must immediately STOP operations.

Recharge the battery before recommending de-mining operations.

Lithium-ion Battery Charger

The detector is supplied with a smart charger.

The charger operates optimally in temperatures between 0°C and 40°C (+32°F to +104°F).

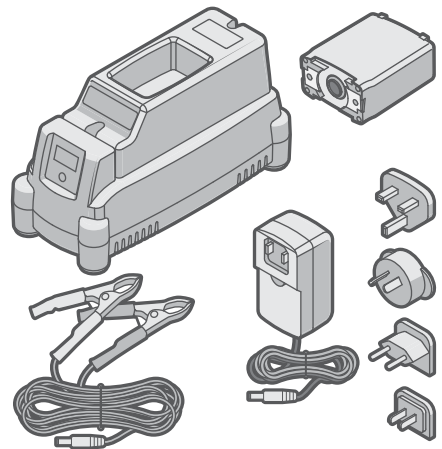

The Lithium-ion battery charger, Lithium-ion battery pack, battery terminal direct connection cable (alligator clips), and a universal AC charger plug pack.



CAUTION: The Charger only supports the Harris 12041-2100/2200/2400 Lithium-ion battery.

Do not use any other battery on this charger. Attempting to charge a battery with the wrong chemistry can lead to an incomplete charge, battery damage, fire or explosion.

For full battery charger operation instructions, specifications and safety information, refer to the instructions included with the charger.

Charging the Lithium-ion Battery

1. Plug the universal AC power pack cable into the back of the charger, and the power pack into a wall outlet. Turn on the power outlet.

The Status LED will illuminate blue when the charger is powered on.

2. Insert the MDS-10 battery into the charging bay of the supplied smart charger.

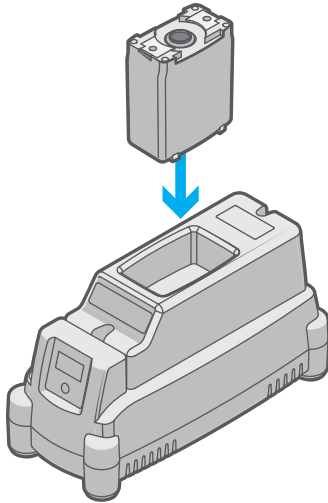

The charger will automatically detect the battery and will begin to charge.

The amber charge status LED will remain on during charging (up to 90%). The Status LED will flash green when the battery is charging above 90%.

3. When charging is complete, the status LED will illuminate solid green.

Leaving the batteries in the charger when fully charged will not cause damage to the battery.





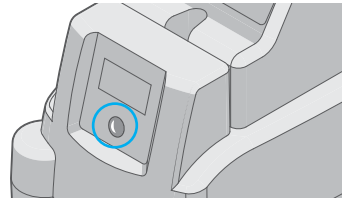

For further Lithium-ion battery safety and maintenance information, read Lithium-ion battery safety and advice on page 63. For further important battery charger information, read Battery charger safety on page 63.

Charge Status LED

The charge status LED displays the current state of the battery.



Charge status LED/Condition button on the Lithium-ion charger.

	Amber solid	Charging
	Amber flashing	Conditioning
	Green solid	Charging complete
	Green flashing	> 90% Charged
	Red solid	Fault
<i>Battery may be faulty or may need to be conditioned.</i>		
	Red Flashing	Temperature error
<i>Charging paused due to temperature (too hot/cold).</i>		

Conditioning the Lithium-ion Battery

Is it not necessary to fully discharge a battery before charging it, however repeated shallow cycling (partially discharging and then topping-up) may cause incorrect battery level status readings.

To recalibrate the battery, the battery must be conditioned.

1. Insert the battery into the powered charger.
2. Press the button (LED) once to access the menu, then select the 'Calibration' option. The conditioning cycle will begin, indicated by the flashing amber charge status LED.
3. When the conditioning cycle is complete, the amber LED will change to solid On, and charging will automatically commence.

Optional AA Battery Carrier

The MDS-10 includes an optional AA battery carrier that holds 16 × AA batteries. This provides a backup option in scenarios where there is no access to mains power for battery charger operation.

The AA battery carrier provides a runtime of over 2 hours in Dual Sensor Mode.

To Prepare the AA Battery Carrier:

1. Unscrew the two retaining screws in the base of the battery carrier using a flat-head screwdriver or a thin coin.

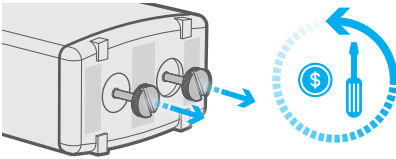

2. Remove the AA battery carrier from its enclosure.
3. Insert 16 full AA batteries, ensuring they are inserted in the correct polarity as marked on the AA battery carrier.

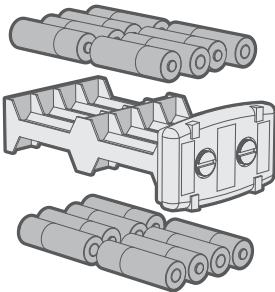

4. Re-insert the AA battery carrier into the enclosure.

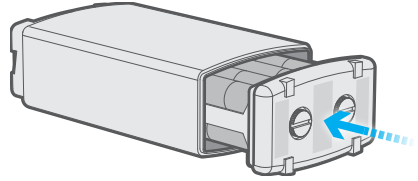

5. Tighten the retaining screws.

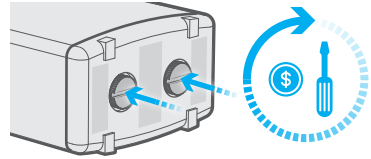

! WARNING:

- Use only new, high quality alkaline AA batteries with the AA battery carrier.
- Do not mix old and new batteries.
- Do not mix battery types or manufacturers.
- Immediately remove and dispose of depleted batteries.
- Do not attempt to charge the AA battery carrier.
- Do not crush, disassemble, reverse polarity, or dispose of the AA battery carrier in fire.

Troubleshooting

If the listed problems occur, perform the recommended actions first before reporting the detector as faulty.

Before performing the recommended actions listed below, perform Factory Reset (page 61).

Problem	Recommended Action
Detector will not turn On	<ol style="list-style-type: none"> 1. Ensure that the battery is charged. 2. Remove and refit the battery.
No LEDs/Audio/ Vibration	<ol style="list-style-type: none"> 1. Check that the LED, Audio, or Vibration Feedback Settings are On for each sensor (page 25). 2. Ensure that Night Vision Mode is disabled (page 24). 3. Ensure that Tactical Mode is disabled (page 26).
LCD display is not working	<ol style="list-style-type: none"> 1. Check that the LCD is On (page 24). 2. Ensure that Night Vision Mode is disabled (page 24). 3. Ensure that Tactical Mode is disabled (page 26).
No sound - Speaker	<ol style="list-style-type: none"> 1. Check the Audio Output Mode is not set to 'Speaker Off' (page 27). 2. Check the Audio Output Mode is not set to 'Speaker Auto-Mute' with an Earset connected (page 27). 3. Check the Volume is set to an audible level (page 27). 4. Check the Audio Feedback Settings are enabled for the applicable sensor (page 25) 5. Check the applicable Sensor is enabled (MD page 29, GPR page 36).
No sound - Earset	<ol style="list-style-type: none"> 1. Check the earset is properly connected. 2. Check the Volume is set to an audible level (page 27). 3. Check the Audio Feedback Settings are enabled for the applicable sensor (page 25) 4. Check the applicable Sensor is enabled (MD page 29, GPR page 36). 5. Remove the earset and inspect the connectors for contamination or damage. 6. Replace the earset.
Excessive MD noise	<ol style="list-style-type: none"> 1. Perform Noise Cancel (page 34). 2. Move away from the source of the noise.
Excessive GPR ground noise	<ol style="list-style-type: none"> 1. Perform GPR Skyshot (page 38). 2. Adjust Start/Stop Gates (page 40). 3. Adjust GPR Sensitivity as necessary (page 39).
Excessive MD ground noise	<ol style="list-style-type: none"> 1. Perform Ground Balance (page 32). 2. Adjust MD Sensitivity as necessary (page 35).
Shafts stuck/don't move smoothly when extending due to sand or dirt contamination	<ol style="list-style-type: none"> 1. Open camlocks and extend shafts fully. 2. Wipe the shafts clean with a clean damp cloth. 3. Collapse and extend shafts repeatedly, cleaning as necessary until shafts move smoothly.

1. Close the affected camlock
2. Using a 3 mm allen key (not included), adjust the camlock screw no more than a one-quarter turn at a time.

Shaft camlocks too loose/tight



3. Check that the camlock opens and closes firmly and without the need for excessive force. If it does not, repeat step 2.
4. Check the camlock holds the shaft securely when closed. If it does not, repeat steps 2 and 3.

! Do not attempt to remove mud with a sharp tool. This may cause damage to the speaker.

1. Gently rinse the speaker under clean water to soften and remove mud. Rinse until the water runs clear.
2. If the mud will not soften, the speaker grill will need to be removed and cleaned by a service technician.

Speaker grill blocked

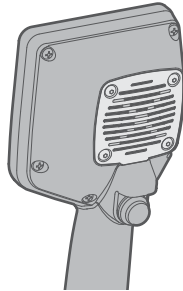

The Speaker Grill on the rear of the User Interface.

1. Tighten the Sensor Head Angle Tension as required.

Sensor Head does not retain the set angle

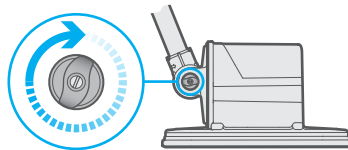

Error Code is displayed on the LCD

1. Power the detector Off then On again.
2. If the Error Code persists, refer to Error Codes on page 58.

Battery is loose/rattling when fitted

1. Remove the battery and check the O-ring is fitted correctly.
2. Inspect the battery mounting interface on the MDS-10 for damage.
3. Replace the battery if required.

Error Codes

In the event of a hardware fault, the MDS-10 will display an Error Code. Try the recommended actions first, before reporting the detector as faulty.

The MDS-10 has a Built-in Test (BIT) capability for identifying faults that can occur in the detector.

 In the event of a BIT failure, the error icon will be displayed on the LCD. If audio is enabled, there will also be a distinctive audio alarm tune.

Error Codes are divided into three types:

- System Error Codes
- MD Error Codes
- GPR Error Codes

An Error Code corresponding to the fault type will usually be displayed on the Setup Screen.

Errors will normally remain active until the detector is powered Off then back On.

Operator corrective actions are limited steps required to reset the detector to determine whether the fault is a transient condition, or if it is persistent. Units with persistent faults will need to be returned an Authorised Service Centre for investigation and repair.

System, MD, and GPR errors have three levels of severity: advisory, critical and fatal.

Critical Errors

Critical errors are conditions affecting detector performance.

Critical errors are indicated by a continuous alarm in all enabled Feedback settings (audio, visual and vibrate). The MD and GPR Target Indicator LEDs will display the Error sequence (alternating between the four left LEDs and the four right LEDs).

For critical MD and GPR errors, the error icon appears on either the left or the right of the Detect Screen to indicate the affected Sensor.

Critical MD and GPR errors can be silenced by disabling the affected sensor, allowing the user to continue detecting with the functional Sensor.

Critical System Errors are indicated by the error icon and a code on the Detect Screen. They can only be reset by powering Off the detector.

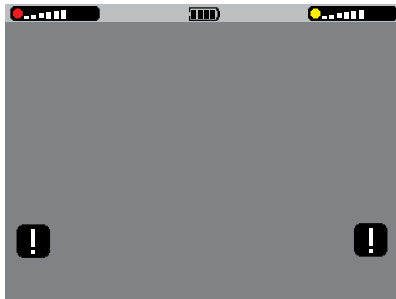

Error icons on the Detect Screen. It appears on the left for critical MD errors, and on the right for critical GPR errors.

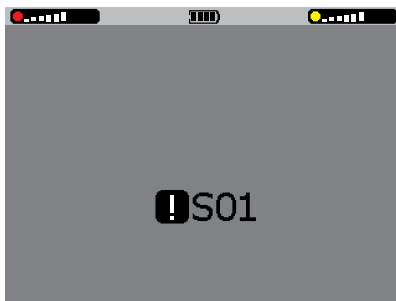

Critical System Error Code on the Detect Screen.

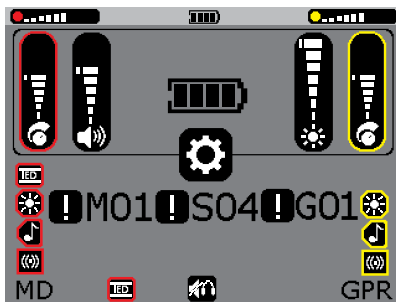

Critical/Advisory Error Codes are displayed on the Setup Screen; MD errors on the left, System errors in the centre, and GPR errors on the right.

Advisory Errors

Advisory errors are conditions that will not affect detector performance.

Advisory errors are indicated by a short error tune, which repeats once every 15 seconds. The advisory error icon appears in the LCD Status Bar.



The Operator may elect to continue detecting as normal in the presence of an advisory error.

The Error Code corresponding to the advisory error can be viewed on the Setup Screen.

Fatal Errors

Fatal errors are conditions that may result in damage to the detector.

If a fatal error occurs, the MDS-10 will automatically shut down immediately, and no Error Codes are displayed.

Fatal Error Recommended Action:

1. Ensure a fully-charged, Minelab approved battery is fitted (the battery supplied with the detector).
2. Turn the detector On.
3. Perform a Factory Reset (page 61).

If the fault persists, return the detector to an Authorised Service Centre.

Code	Fault	Severity
N/A	Overcurrent condition	Fatal
N/A	Overvoltage condition	Fatal
N/A	Undervoltage condition	Fatal

System Error Codes

System Error Codes indicate a possible electronic fault with the system affecting both the MD and GPR Sensors.

For advisory system errors, an Error Code corresponding to the fault will be displayed in the centre of the Setup Screen.

Critical system Error Codes are displayed in the centre of the Detect Screen. All detector functions are disabled, and the only option to reset the error is to turn the detector Off and then On again.

System Error Recommended Action:

1. Turn the detector Off and then On again.
2. Perform Factory Reset (page 61).

If the fault persists, return the detector to an Authorised Service Centre.

Code	Fault	Severity
S01	User interface module authentication failure	Critical
S02	Battery type detection fault	Critical
S03	UIM configuration load failure	Critical
S04	UIM settings load failure	Advisory

MD Error Codes

MD Error Codes indicate a possible fault with the MD coil or MD coil cable in the Sensor Head, or the MD electronics in the control box.

If an MD fault occurs, the error icon will appear on the Detect Screen, adjacent to the MD Sensor Feedback icons on the left.

The Error Code corresponding to the fault will be displayed on the left of the Setup Screen.

MD Coil Error Recommended Action:

1. Disable/enable MD Sensor.
2. Turn the detector Off and then On again.
3. Perform Factory Reset (page 61).

If the fault persists, return the detector to an Authorised Service Centre.

Code	Fault	Severity
M01	Control box incompatible error	Critical
M02	Control box comms fault error	Critical
M03	MD Tx fault	Critical
M04	MD Rx fault	Critical
M05	MD VTX out of range	Critical
M06	MD A4V out of range	Critical
M07	Coil auth failure	Critical
M08	Control box auth failure	Critical
M09	Coil calibration load failure	Critical
M10	Control box calibration load failure	Critical
M11	Control box temperature sensor 1 over range	Advisory
M12	Control box temperature sensor 1 under range	Advisory
M13	Control box temperature sensor 2 over range	Advisory
M14	Control box temperature sensor 2 under range	Advisory

GPR Error Codes

GPR Error Codes indicate a possible fault with the GPR Sensor.

If a GPR fault occurs, the Error icon will appear on the Detect Screen, adjacent to the GPR Sensor Feedback icons on the right.

The Error Code corresponding to the fault will be displayed on the right of the Setup Screen.

GPR Error Recommended Action:

1. Disable/Enable GPR Sensor.
2. Perform Skyshot.
3. Turn the detector Off and then On again.
4. Perform Factory Reset (page 61).

If the fault persists, return the detector to an Authorised Service Centre.

Code	Fault	Severity
G01	GPR incompatible error	Critical
G02	GPR comms fault error	Critical
G03	GPR DSP code load fault	Critical
G04	GPR FPGA code load fault	Critical
G05	GPR DSP start-up fault	Critical
G06	GPR Skyshot fault	Critical
G07	GPR HV calibration fault	Critical
G08	GPR trigger table load fault	Critical
G09	GPR DCP peaks invalid fault	Critical
G10	GPR scan rate fault	Critical
G12	GPR MEMS fault	Advisory
G13	GPR frame gap warning	Advisory
G14	GPR DCP peak warning	Advisory
G27	GPR option ROM not accessible	Advisory

Factory Presets

The factory preset detector settings are the default and recommended base-settings for typical detecting operations.

Factory Preset Settings

Function	Default Setting
Sensor Mode	Dual Sensor Mode (MD and GPR)
Volume	6
Audio Output Mode	Speaker Auto-Mute
Ground Balance Mode	IED
LCD/LED Brightness	7
LCD/LED Setting	On
MD Sensitivity	6
MD LED Response	Enabled
MD Audio Response	Enabled
MD Vibration Response	Enabled
GPR Sensitivity	6
GPR LED Response	Enabled
GPR Audio Response	Enabled
GPR Vibration Response	Enabled
GPR Start Gate	0
GPR Stop Gate	-100
GPR Detection Threshold	30

Factory Reset

Factory Reset will return all detector settings and modes to factory preset values.

1. Turn the detector Off.
2. Press and hold the Setup (power) button for approximately 5 seconds;
3. After the first start-up tone, there will be a short high-pitched confirmation tone, and all settings and modes will return to factory preset values.
4. Release the Setup (power) button.

Safety Advice and Maintenance

The MDS-10 is safe to transport, store and operate when handled with the due care. Safety hazards applicable to this equipment are identified below.

Hazard	Precaution
Emission of non-ionising radiation.	<p>The GPR and MD Sensors in the Sensor Head emit very low power magnetic fields and Radio Frequency (RF) energy. The radiated energy from both Sensors is significantly lower than that emitted by a mobile telephone and is safe to human health.</p> <p>Operators do not need to follow any specific safety precautions to mitigate hazards to human health posed by the emission of non-ionising radiation from the equipment.</p>
Electromagnetic interference	<p>While interference with communications equipment is unlikely, consideration should be given to potential effects on other equipment in proximity.</p>
Internal voltages	<p>Voltages potentially capable of causing electric shock are present on some internal conductors in both the GPR and MD Sensors.</p> <p>Inspect the MDS-10 shafts, Sensor Head enclosure, Control Box enclosure, and Battery for evidence of damaged or exposed cables or electrical conductors prior to use. Do not use the equipment if there is any evidence of damaged or exposed cables or electrical conductors.</p>
Speaker/earset audio volume	<p>Exposure to excessively high audio volumes with any audio generating equipment can cause discomfort and possible temporary and permanent hearing loss. The maximum output volume via the earset and speaker for the detector are limited to be within safe levels for peak sound pressure level exposure. Operators should also use the Volume control to ensure the audio volume is not set above comfortable levels.</p> <p>Ensure the Volume control is not set above comfortable levels during operation.</p>
Air transport safety requirements	<p>The MDS-10 should not be powered On while being transported by air, and all applicable safety regulations must be followed in relation to carriage of electronic equipment, including lithium-ion batteries on aircraft.</p> <p>Follow all applicable safety regulations including the directions from aircrew when transporting MDS-10 equipment by air.</p>
Ergonomic hazards	<p>The MDS-10 is a lightweight Dual Sensor detector, designed to minimise the risk of fatigue, strain, or other musculoskeletal injury to Operators. Operators using the equipment should always observe correct detecting posture and technique.</p>
Exposed fibres from damaged carbon fibre shafts	<p>Inspect the detector shafts prior to use. Do not allow damaged or abraded carbon fibre shaft sections to come into contact with skin.</p> <p>The MDS-10 middle and upper shafts are made from carbon fibre material. Damaged or abraded carbon fibre materials can expose fibres which can cause cuts and abrasions to skin, and ingress under the skin with potentially toxic effects.</p>
Pinch-points	<p>The MDS-10 has been designed to avoid the presence of pinch-points, but is a compact, collapsible piece of equipment that requires moderate care when extending or collapsing. Keep fingers clear of sliding and rotating mechanisms including shaft camlocks, and around the base of the folding handle in the vicinity of the earset connector, when extending or collapsing the detector.</p>

Hazard	Precaution
Lithium-ion battery safety and advice	<p>The MDS-10 comes with a high capacity, rechargeable lithium-ion battery. Both the battery and MDS-10 provide internal protection circuitry to ensure safe operation of the battery. All local regulations related to the operation, handling, storage and transportation of lithium-ion batteries must be observed, including the following:</p> <ul style="list-style-type: none"> • Inspect lithium-ion batteries before use. Do not use batteries with the equipment if damaged in any way. • Do not short circuit or reverse polarity the lithium-ion batteries. Fire or explosion may result. • When fitting batteries to the detector, ensure the O-ring on the battery around the contacts is fitted to prevent moisture, sand or dust fouling the battery contacts. • Do not use or store the lithium-ion batteries outside the specified operating temperature range for the Detector. • Do not recharge the lithium-ion batteries with anything other than the battery charger supplied with the equipment. • Do not allow the lithium-ion battery internal cells to fully discharge. <i>(Note: batteries may be safely operated until the MDS-10 shuts down due to low battery, without fully discharging the battery internal cells.)</i> • Ensure batteries have at least a partial charge if prolonged storage is anticipated. • Do not expose lithium-ion batteries to fire, explosion, solvents or corrosives or other hazardous substances. • Do not incinerate, puncture, crush, or otherwise damage or misuse lithium-ion batteries. • Do not transport lithium-ion batteries by aircraft except where explicitly authorised under applicable air transport regulations. Observe all applicable regulations when transporting the equipment. • Dispose of lithium-ion Batteries only in accordance with all applicable local and national environmental regulations. • Recharge the battery after long periods of non-use to maximise battery life (approximately every 6 months)
Battery charger safety	<p>The charger has been constructed from quality materials and is designed to be maintenance-free.</p> <ul style="list-style-type: none"> • Do not attempt to charge batteries other than the Harris 12041-2400 series batteries supplied with the MDS-10 using the supplied charger. Attempting to charge a battery with the wrong chemistry can result in an incomplete charge, battery damage, fire or explosion. • Do not substitute the AC power supply supplied with battery charger for any other AC power supply. • Do not attempt to charge batteries outside of the recommended charging temperature range of 0°C to +40°C (+32°F to +104°F). • Do not block the ventilation slots. • Keep away from moisture. Clean only with a dry or slightly damp lint-free cloth. • Do not remove cover. The charger has no internal user-serviceable parts.

MDS-10 Detector Specifications

General Specifications

Sensor Operation Modes	MD (Metal Detector) GPR (Ground Penetrating Radar) Dual
Volume Control	1 to 9
Packed Dimensions	660 × 485 × 232 mm (25.9" × 19.1" × 9.1")
Packed Weight	13.7 kg (30.2 lb)
Detector Length	Collapsed: 475 mm (18.7") Extended: 1567 mm (61.7")
Detector Weight	2.8 kg (6.17 lb)
Audio Output	Speaker MDS-10 Earset connector
Earset	MDS-10 Earset
Display	3.5" 320 × 240 resolution (QVGA) LCD
Display Backlight	Dual Mode backlight: High brightness transmissive 1 to 7 Brightness Levels NVIS compatible mode
Waterproof	Waterproof to 3 m/10-feet*
Operating Temperature Range	-30°C to +60°C (-22°F to +140°F)
Storage Temperature Range	-50°C to +80°C (-58°F to +176°F)
Environmental	MIL-STD-810G
Software Upgradeable	Yes
Battery	12041-2400-02 Rechargeable lithium-ion 10.8 V, 74 Wh (7.0 Ah) (common with AN/PRC-152 radio battery)
Battery Life	7 hours (Dual Sensor Mode) 10 hours (MD Sensor Mode) 8 hours (GPR Sensor Mode)
Charging Temperature Range	0°C to +45°C (+32°F to +113°F)
AA Battery Pack	16 × Alkaline AA Batteries Runtime: 2.25 hours (Dual Sensor Mode)

** Although the MDS-10 can withstand immersion to a depth of 3 metres (10-feet) for short periods of time, it is NOT designed for use as an underwater detector.*

Metal Detection Sensor Specifications

Key Technologies	Simultaneous Multi-Frequency Digital
Coil	Transmit Coil: 269 × 191 mm (10.6" × 7.5") Monoloop Receive Coil: Figure 8
Operating Frequencies (kHz)	4 frequencies in the range 6 kHz to 75 kHz
MD Sensitivity	1 to 10
Noise Cancel	Automatic, Operator initiated
Ground Balance	Automatic, Operator initiated
Target Identification	Conductive: 0 to 9 Ferrous: Indicated

GPR Detection Sensor Specifications

Key Technologies	Ultra Wide-Band (UWB) Impulse Radar
Bandwidth (GHz)	> 5 GHz
GPR Sensitivity	1 to 10
GPR Skyshot	Automatic, Operator initiated
GPR Imagery	4 s waterfall display of subsurface anomalies with target overlay highlights.

Minelab reserves the right to respond to ongoing technical progress by introducing changes in design, equipment and technical features at any time.

For the most up-to-date specifications for MDS-10, visit www.minelab.com/countermine

